

1: 10.3x ↗	6: 9.2 ↘	<b>Series</b>	100.9
2: 9.9 →	7: 10.5x ↘		
3: 9.8 ↘	8: 10.4x ↘	<b>Series</b>	100.9
4: 9.6 ←	9: 10.0 ↘		
5: 10.3x ↖	10: 10.9x ↖		

1: 10.0 ↓	6: 10.5x →	<b>Series</b>	101.2
2: 10.0 ↖	7: 9.2 ←		
3: 10.7x ↗	8: 10.1 ↗	<b>Series</b>	202.1
4: 10.3x ↗	9: 10.1 ↖		
5: 10.5x ↘	10: 9.8 →		

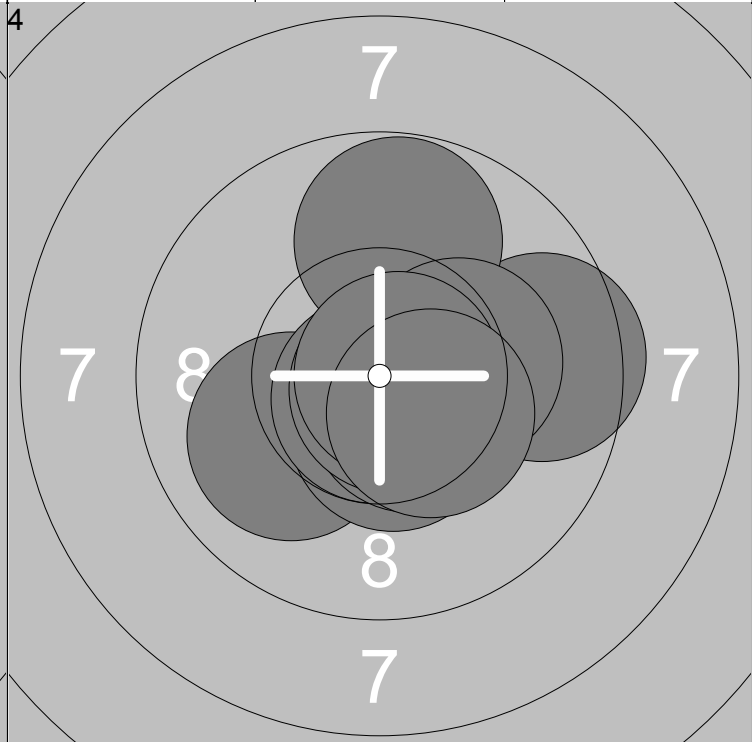
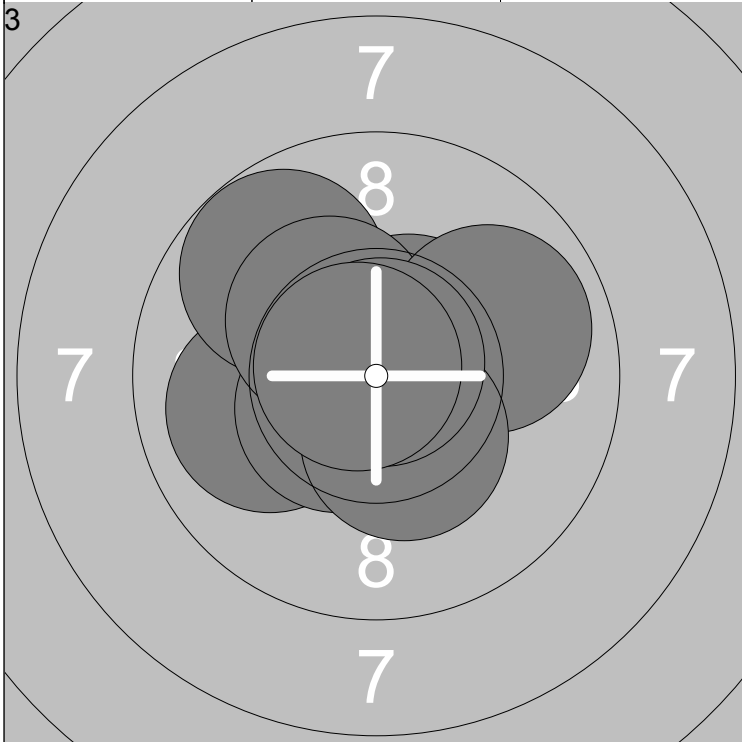

1: 10.0 ←	6: 10.3x ↗	<b>Series</b>	103.6
2: 10.6x ↗	7: 9.9 →		
3: 10.5x ↗	8: 10.4x ↘	<b>Series</b>	305.7
4: 9.8 ↗	9: 10.8x ↗		
5: 10.5x ↘	10: 10.8x ↖		

1: 9.6 →	6: 10.6x ↘	<b>Series</b>	103.5
2: 9.8 ↗	7: 10.3x →		
3: 10.0 ↖	8: 10.8x ↘	<b>Series</b>	409.2
4: 10.5x ↘	9: 10.8x →		
5: 10.7x ↘	10: 10.4x ↘		

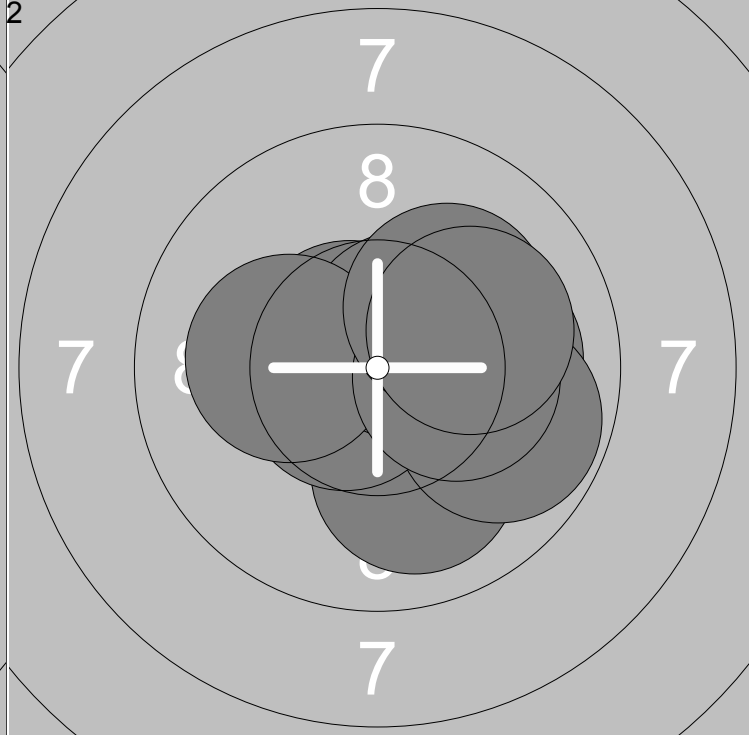
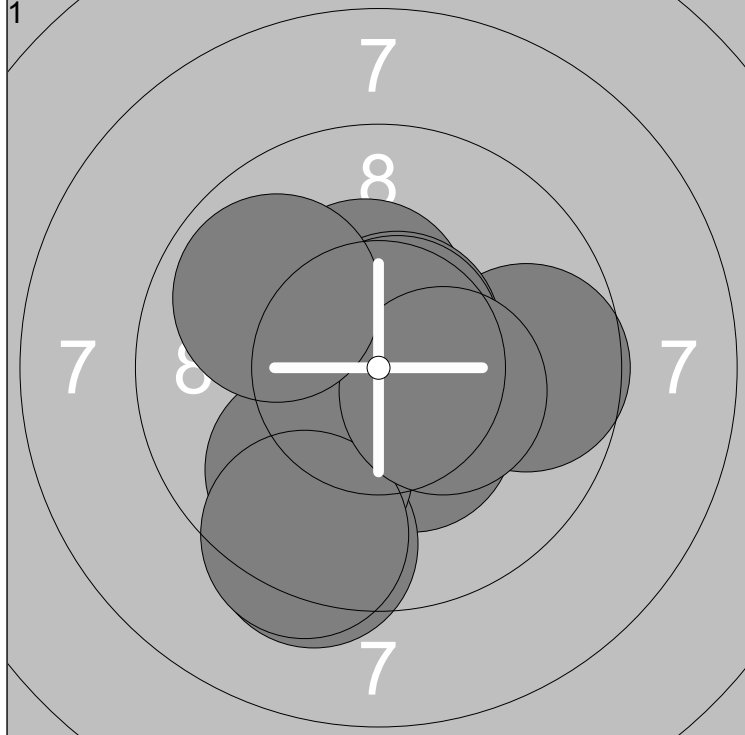

1: 9.7 →	6: 9.3 ↓	Series	100.5
2: 10.4x ↓	7: 9.9 ↓		
3: 10.4x ↑	8: 9.4 ↓		
4: 10.6x ↗	9: 10.3x →		100.5
5: 10.6x ↗	10: 9.9 ↖		

1: 10.1 →	6: 10.6x ↗	Series	102.5
2: 10.6x ↗	7: 10.2x ←		
3: 10.0 ↓	8: 10.3x →		
4: 9.8 →	9: 10.2x ↗		203.0
5: 10.6x ↙	10: 10.1 →		

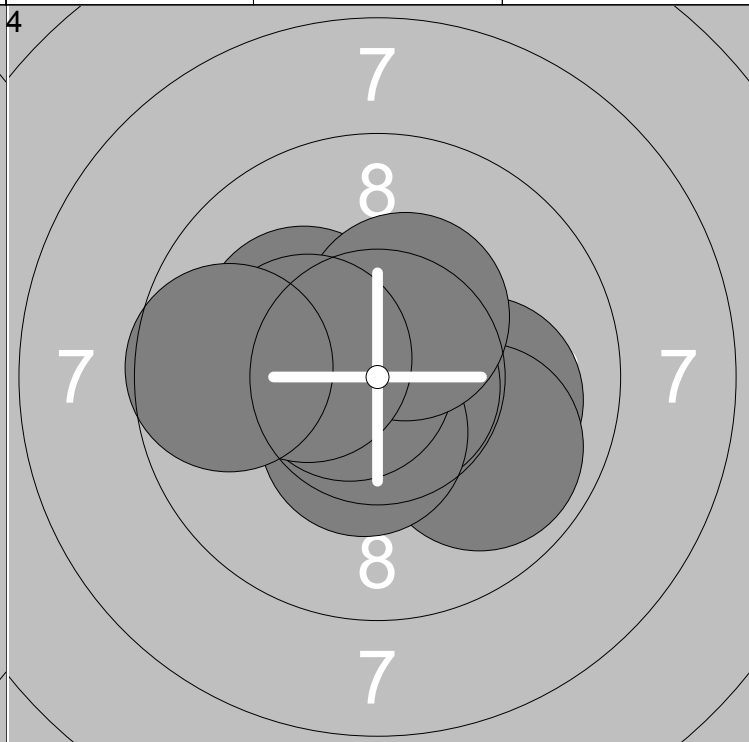
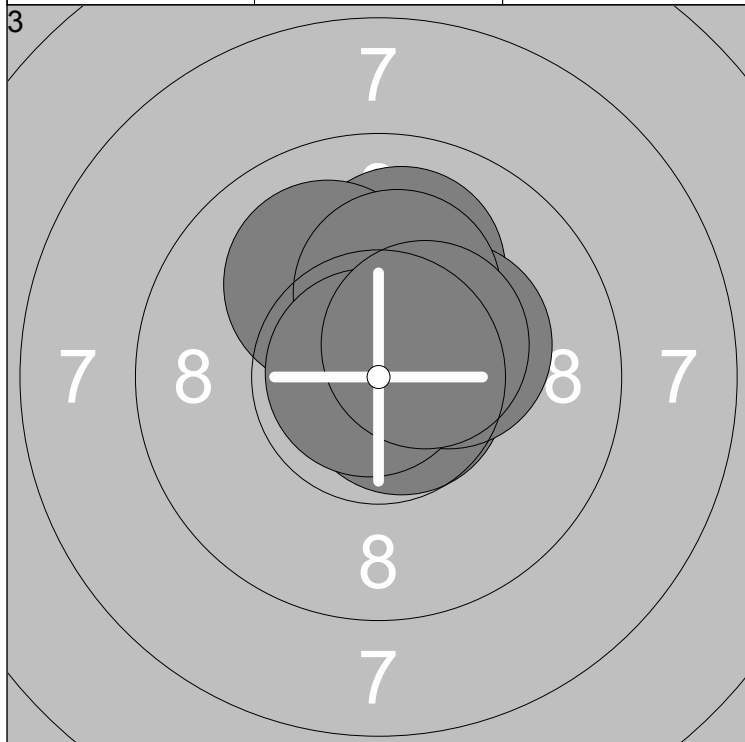

1: 10.0 ↑	6: 10.3x ↗	Series	104.5
2: 10.6x ↗	7: 10.6x ↗		
3: 10.7x →	8: 10.2x ↑		
4: 10.6x ↑	9: 10.9x ↖		307.5
5: 10.1 ↖	10: 10.5x ↗		

1: 10.0 →	6: 10.4x ↓	Series	103.0
2: 9.9 ↓	7: 10.7x ←		
3: 10.8x →	8: 10.4x ↑		
4: 10.6x ←	9: 10.3x ←		410.5
5: 10.2x ↖	10: 9.7 ←		

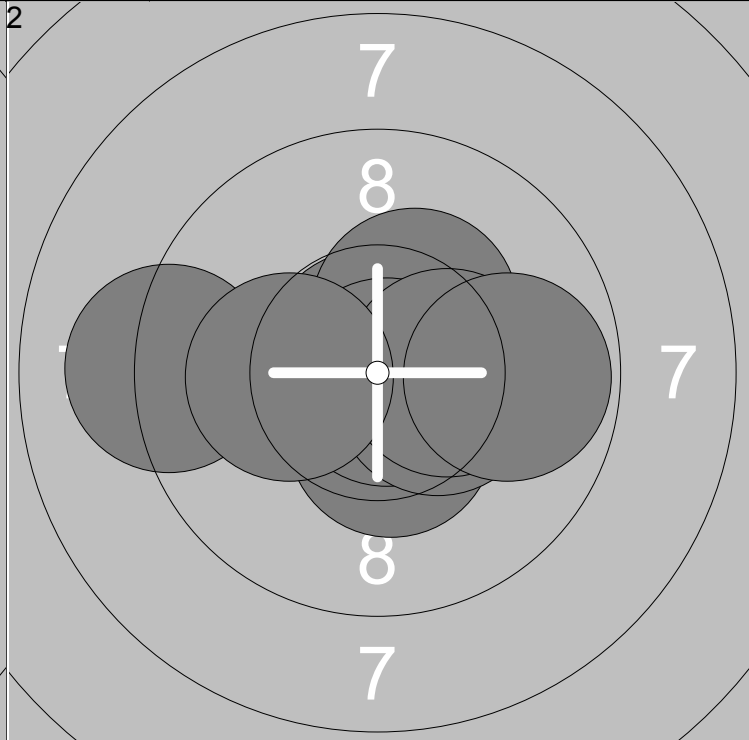
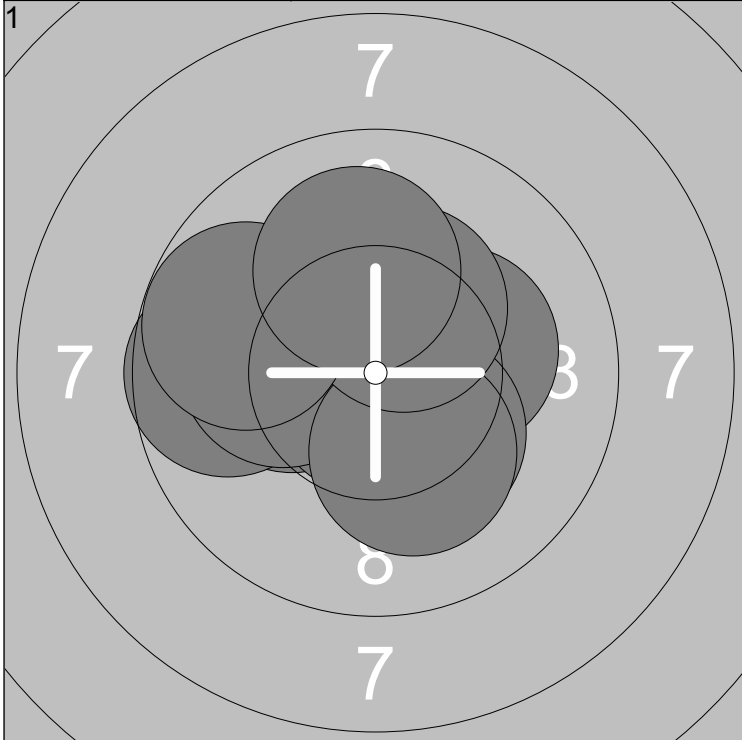

1: 10.2x ←	6: 10.1 ←	Series	101.6
2: 10.2x →	7: 10.2x ↓		
3: 10.8x ↓	8: 10.3x ↗	101.6	
4: 9.7 ←	9: 9.7 ←		
5: 10.3x ↓	10: 10.1 ↗		

1: 10.2x →	6: 10.8x ↓	Series	102.3
2: 10.8x ↗	7: 10.4x →		
3: 10.4x ↓	8: 10.3x →	203.9	
4: 10.3x ↗	9: 10.2x ←		
5: 9.1 ←	10: 9.8 →		

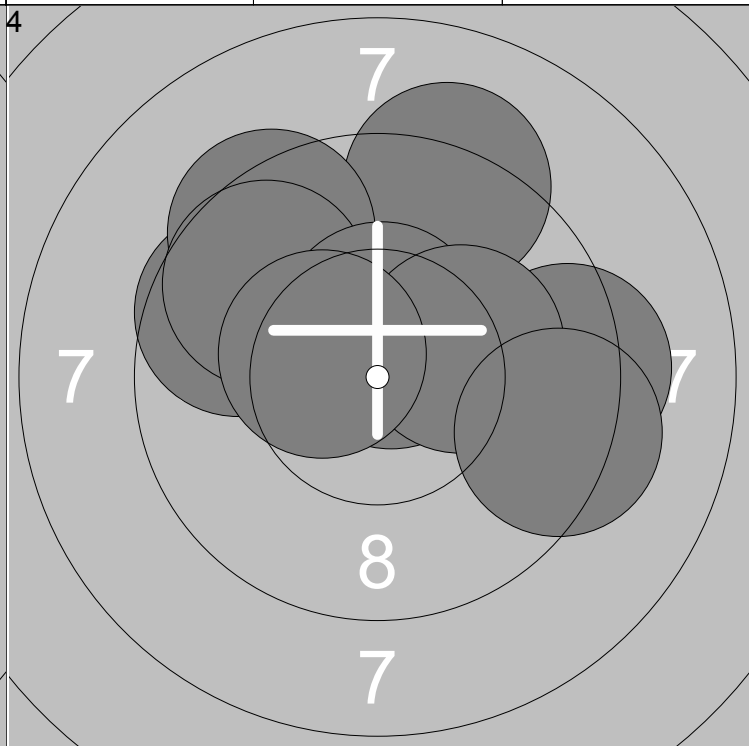
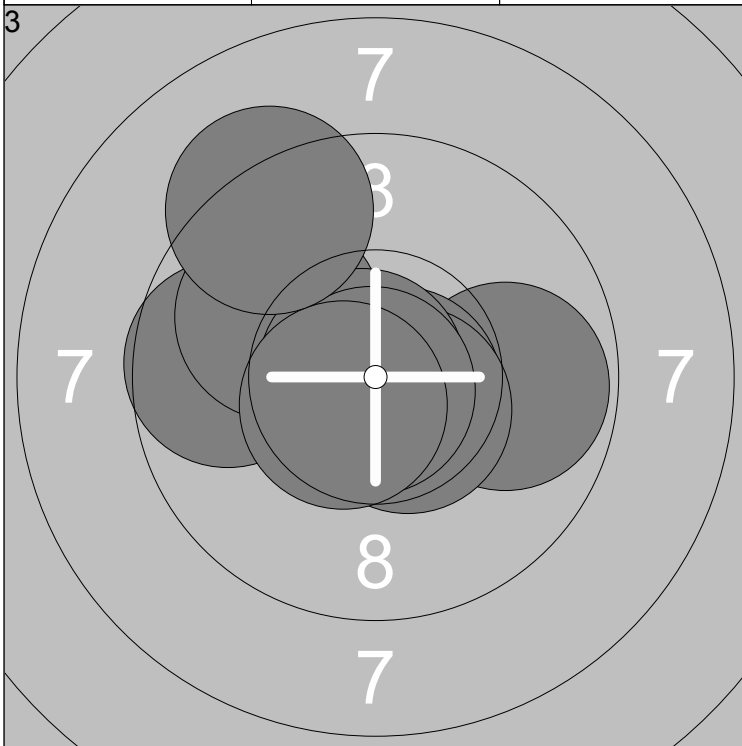

1: 9.7 ←	6: 10.6x ↓	Series	103.0
2: 10.0 ↗	7: 10.8x ←		
3: 9.8 →	8: 10.8x ↓	306.9	
4: 10.7x ↘	9: 10.6x ←		
5: 10.8x ↓	10: 9.2 ↗		

1: 9.3 →	6: 9.7 ↖	Series	98.3
2: 10.7x ↗	7: 10.5x ↑		
3: 9.2 ↗	8: 10.2x →	405.2	
4: 9.6 ←	9: 10.4x ←		
5: 9.4 ↗	10: 9.3 →		

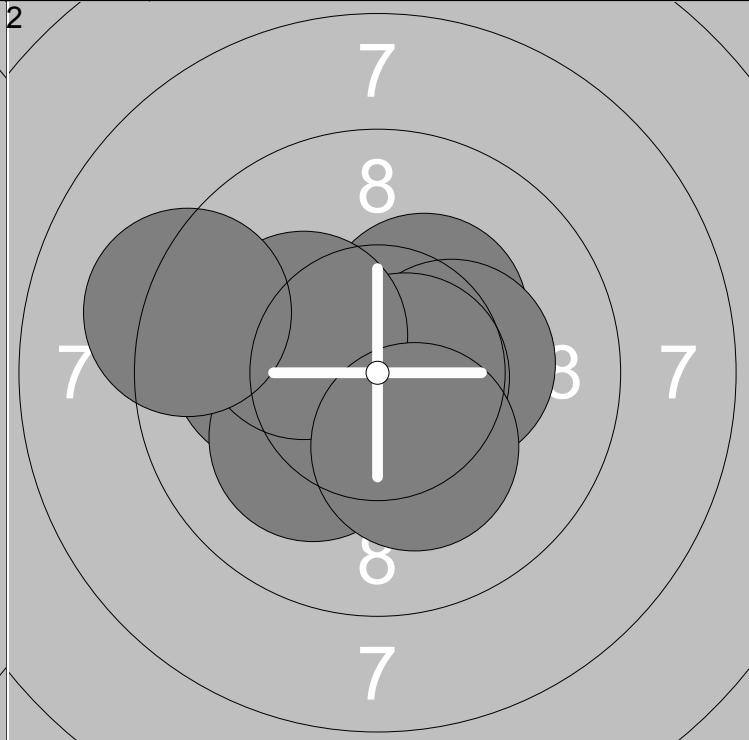
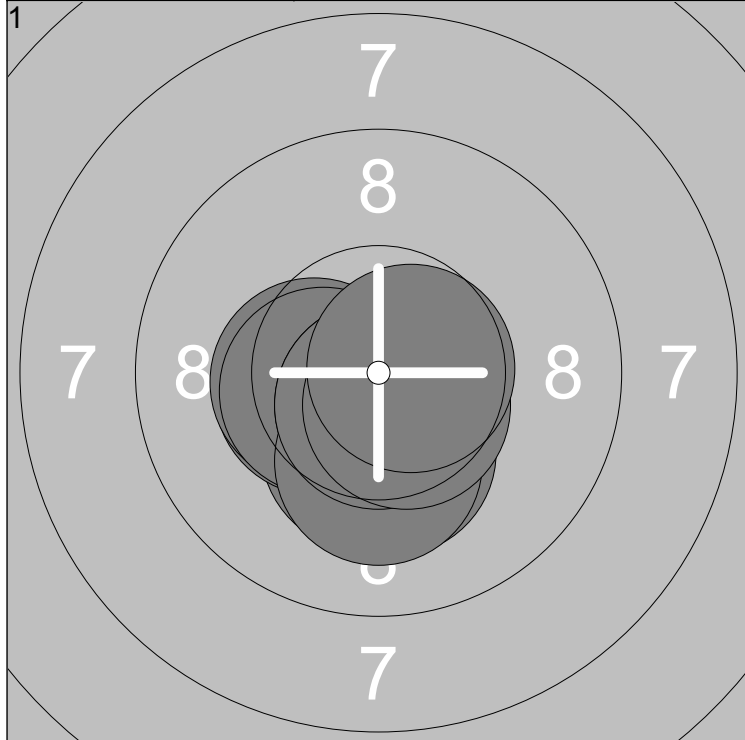

1: 10.3x ↓	6: 10.7x ↓	Series	104.7
2: 10.4x ←	7: 10.2x ↓		
3: 10.4x ←	8: 10.7x ↓	Series	104.7
4: 10.4x ←	9: 10.6x ↓		
5: 10.3x ↓	10: 10.7x →		

1: 10.3x ↗	6: 10.7x →	Series	102.5
2: 10.1 ←	7: 10.2x ↓		
3: 10.3x →	8: 10.2x ↙	Series	207.2
4: 10.6x ↓	9: 10.2x ↓		
5: 10.7x ↙	10: 9.2 ←		

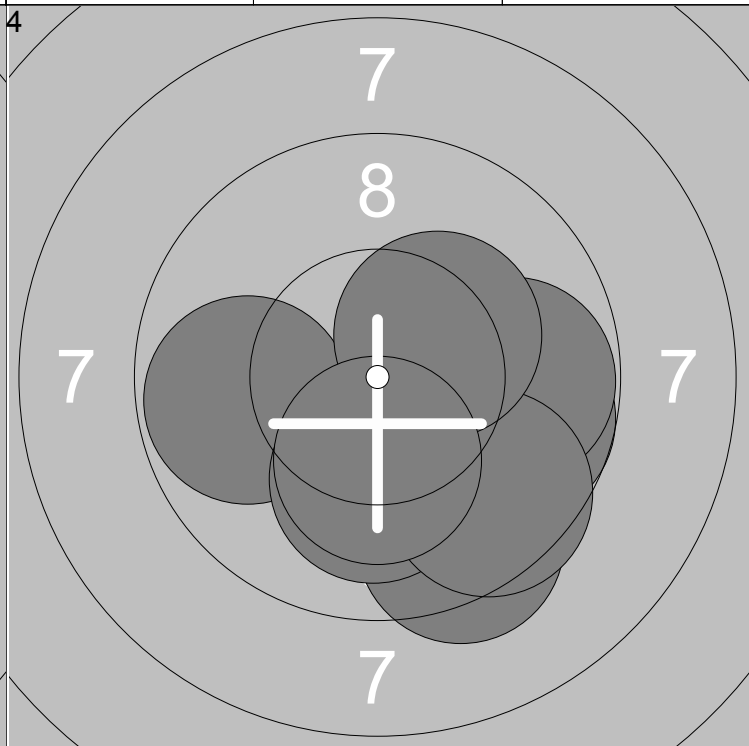
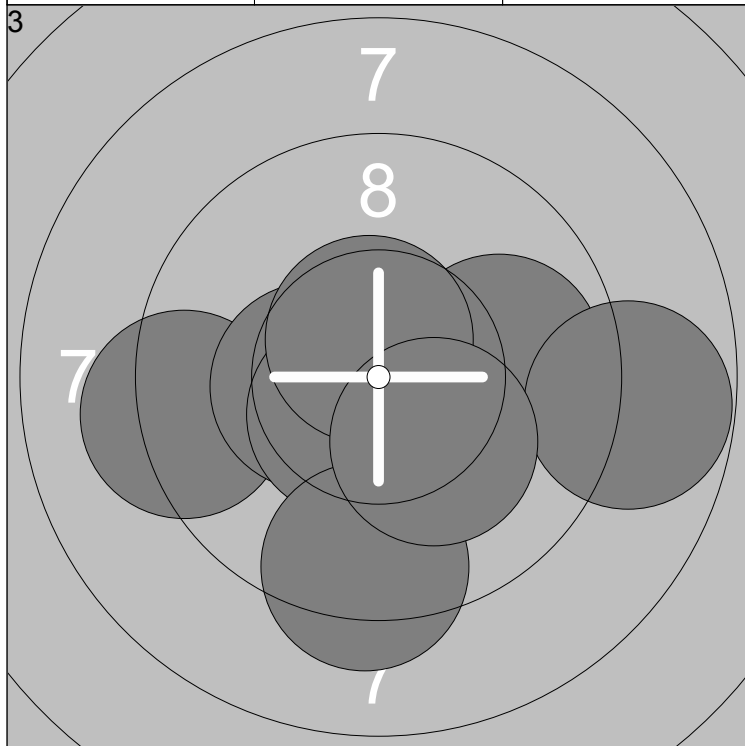

1: 9.3 ←	6: 10.4x ←	Series	100.6
2: 10.8x ↗	7: 10.5x ↙		
3: 10.8x →	8: 9.3 ↓	Series	307.8
4: 9.9 →	9: 10.6x ↗		
5: 8.8 →	10: 10.2x ↙		

1: 10.5x ↓	6: 9.8 ←	Series	99.8
2: 9.7 →	7: 10.1 ↓		
3: 9.8 →	8: 9.6 ↓	Series	407.6
4: 9.4 ↓	9: 10.3x ↗		
5: 10.4x ↓	10: 10.2x ↓		

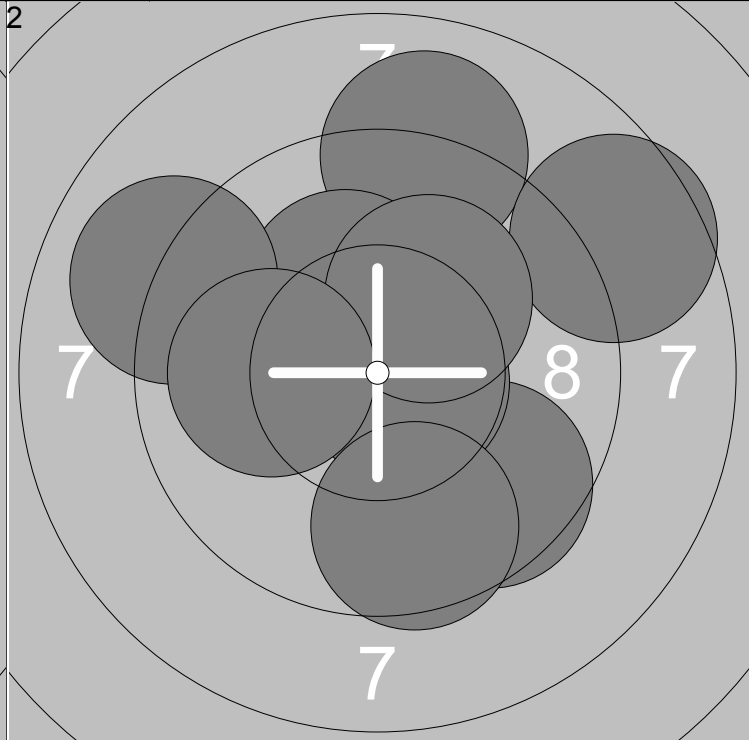
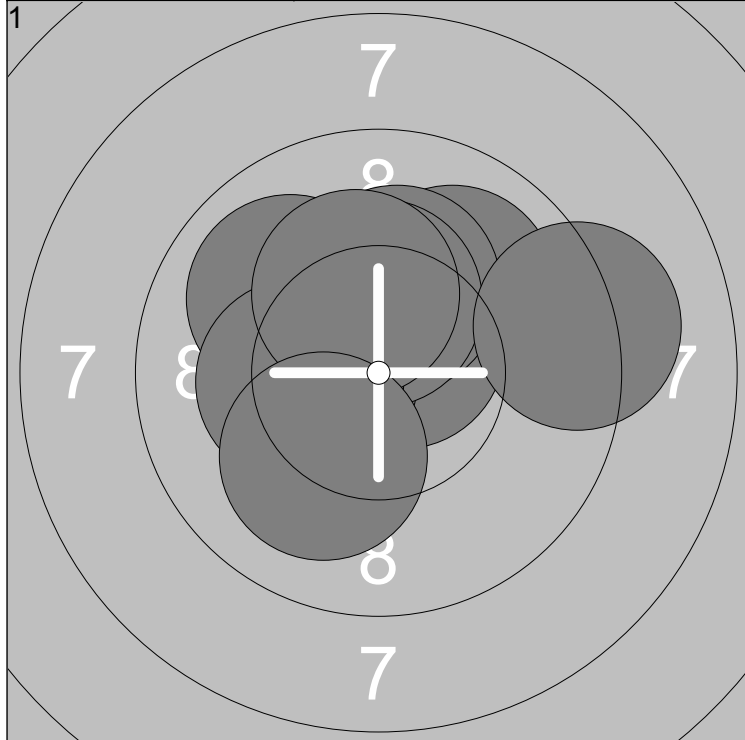

1: 10.0 ↗	6: 10.3x ↑	Series	101.4
2: 10.0 ↖	7: 10.3x ←		
3: 10.6x ↗	8: 10.3x ↑	101.4	
4: 10.4x ←	9: 9.2 →		
5: 10.2x ↑	10: 10.1 ↘		

1: 9.0 ↑	6: 9.0 ↖	Series	97.4
2: 10.5x ↗	7: 10.7x →		
3: 8.6 ↗	8: 10.2x ↗	198.8	
4: 10.2x ↑	9: 9.6 ↓		
5: 9.6 ↘	10: 10.0 ←		

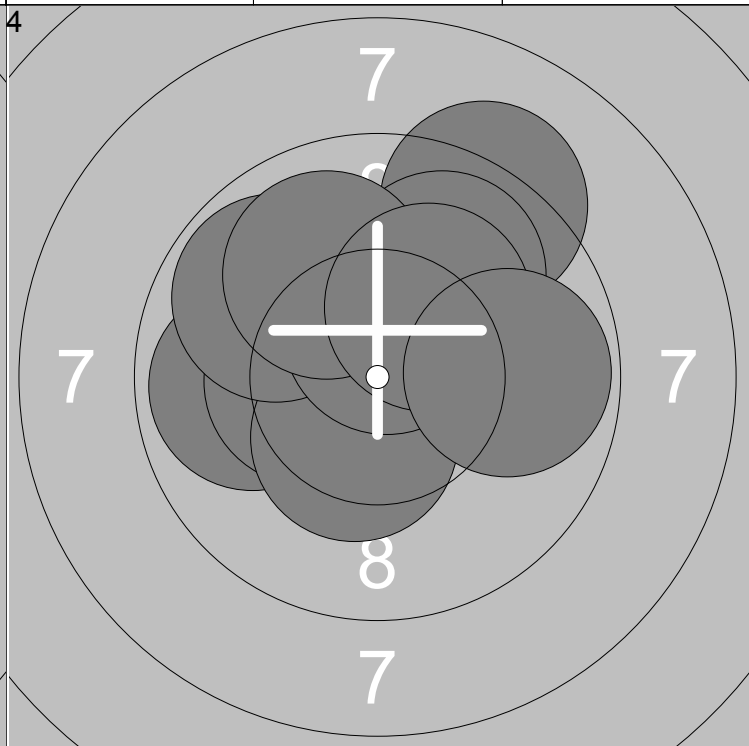
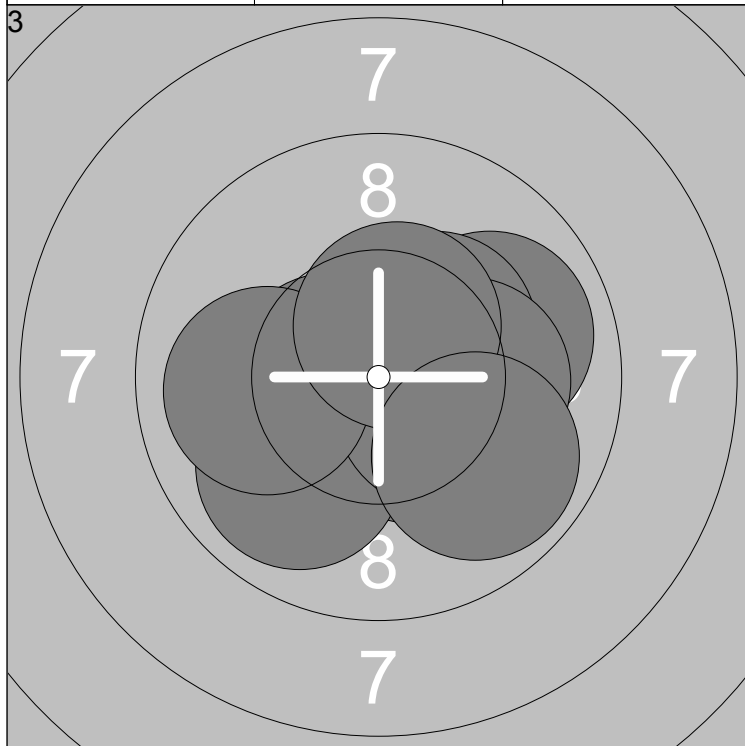

1: 10.5x ↘	6: 10.4x →	Series	102.2
2: 9.9 →	7: 10.2x →		
3: 10.3x ↗	8: 10.0 ←	301.0	
4: 10.6x ←	9: 10.5x ↑		
5: 9.9 ↘	10: 9.9 ↘		

1: 9.9 ←	6: 9.9 ↗	Series	100.0
2: 10.3x ←	7: 10.5x ↑		
3: 9.2 ↗	8: 10.0 ↖	401.0	
4: 10.4x ↘	9: 10.2x ↗		
5: 9.8 ↖	10: 9.8 →		

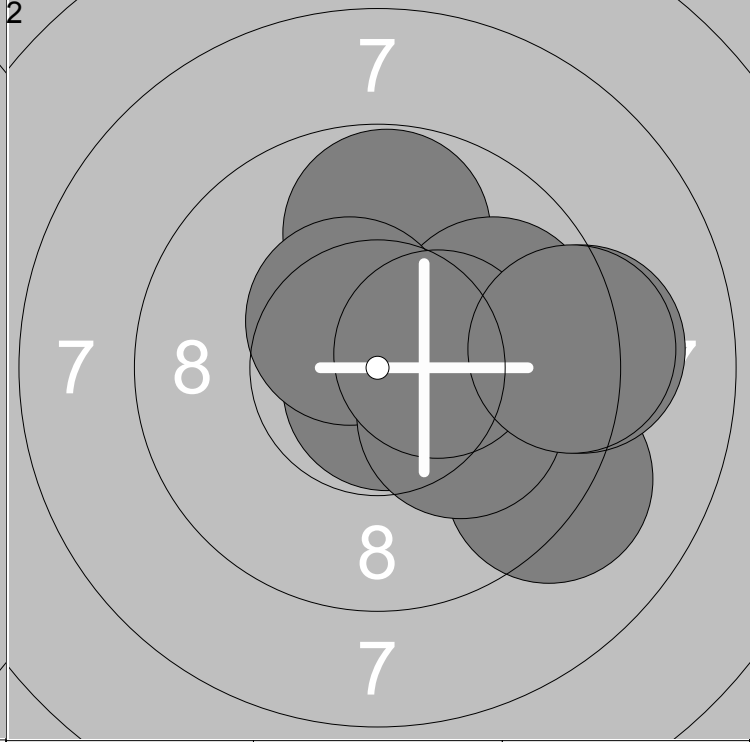
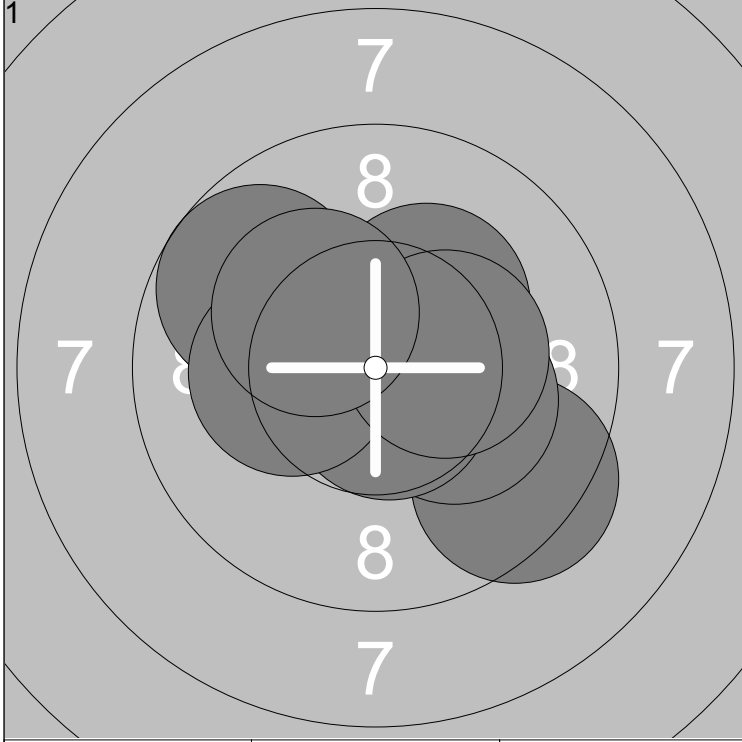

1: 10.8x ←	6: 10.7x ↓	Series	102.3
2: 9.4 ↓	7: 10.3x ↗		
3: 10.5x ←	8: 10.2x ←	Series	102.3
4: 10.2x ↘	9: 10.3x →		
5: 9.7 ↗	10: 10.2x ↖		

1: 10.4x ↗	6: 10.5x ↖	Series	99.6
2: 10.8x ↓	7: 10.1 ↓		
3: 9.8 ↑	8: 9.2 →	Series	201.9
4: 9.2 ↘	9: 10.4x →		
5: 9.9 ↗	10: 9.3 →		

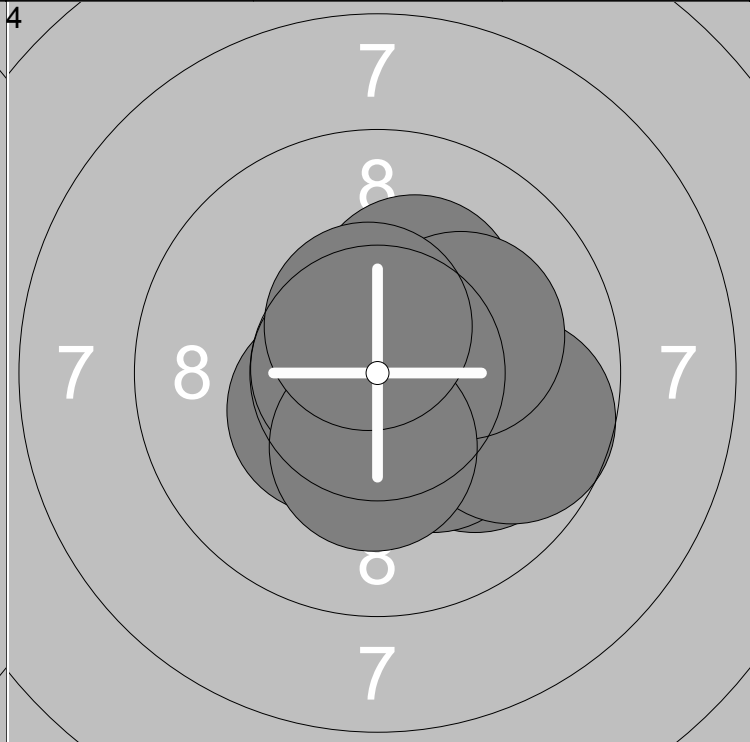
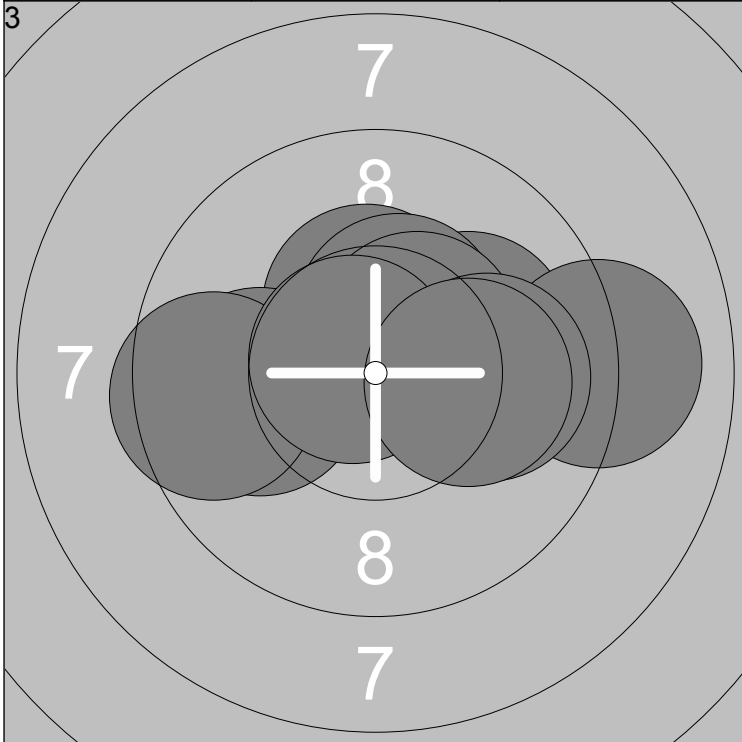

1: 10.1 →	6: 9.5 ←	Series	100.7
2: 10.4x ↑	7: 10.5x ↗		
3: 9.9 ←	8: 10.7x ↖	Series	302.6
4: 10.4x ↗	9: 10.0 →		
5: 9.0 →	10: 10.2x →		

1: 10.4x ↖	6: 10.8x ←	Series	103.2
2: 10.2x ↗	7: 9.7 →		
3: 10.0 ↘	8: 10.2x →	Series	405.8
4: 10.3x ↘	9: 10.3x ↓		
5: 10.8x ←	10: 10.5x ↑		

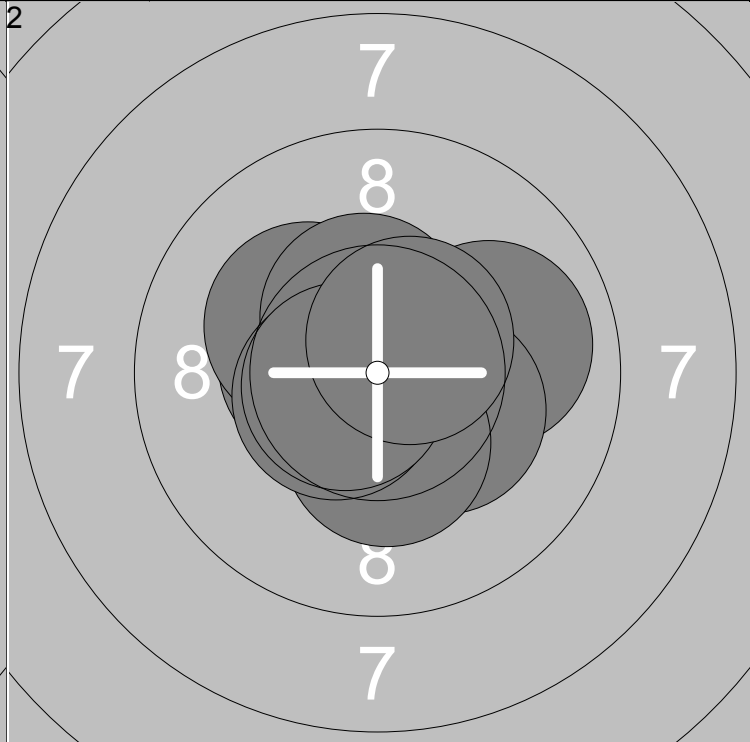
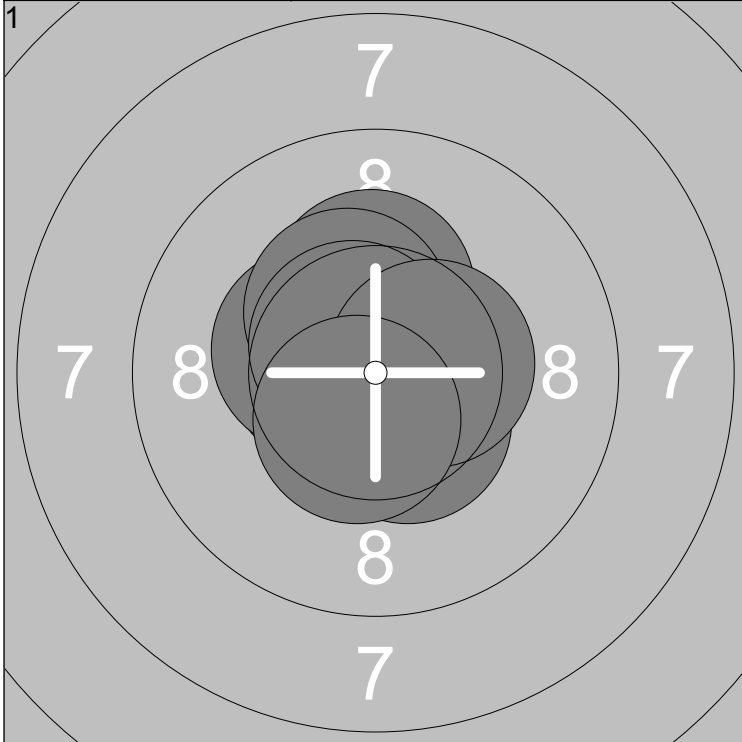

1: 10.8x ↘	6: 10.5x ↘	<b>Series</b> 105.2
2: 10.6x ←	7: 10.4x ↗	
3: 10.6x ↘	8: 10.6x ↗	105.2
4: 10.3x ↑	9: 10.5x →	
5: 10.4x ↖	10: 10.5x ↘	

1: 10.5x ←	6: 10.3x ↘	<b>Series</b> 104.1
2: 10.2x ↖	7: 10.3x ↓	
3: 10.6x ↗	8: 10.5x ←	209.3
4: 10.0 →	9: 10.6x ←	
5: 10.5x ↗	10: 10.6x ↗	

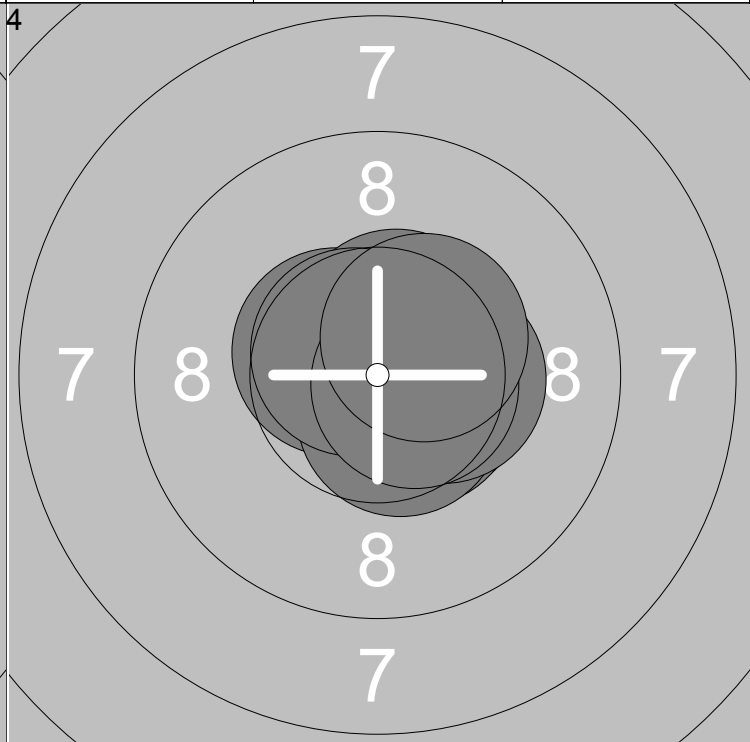
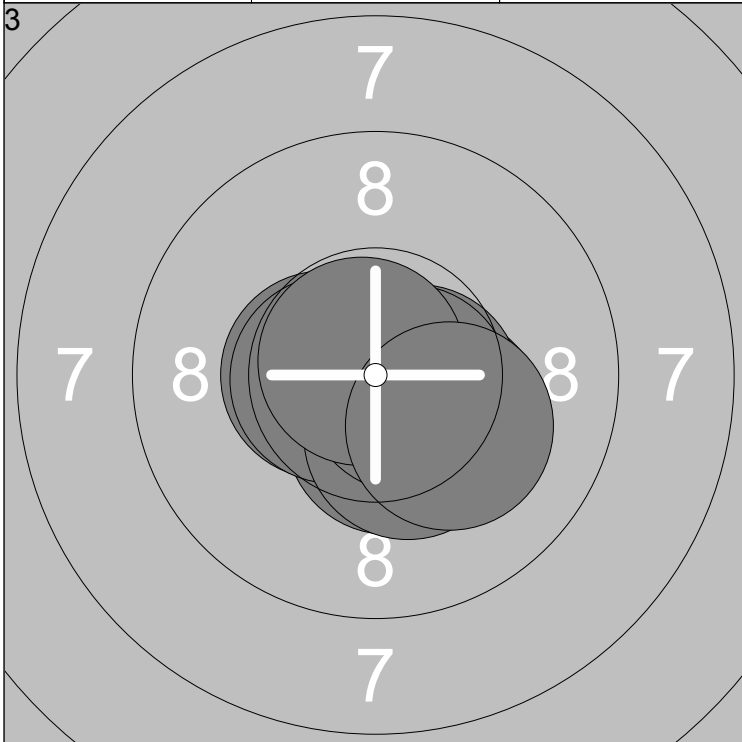

1: 10.3x ↘	6: 10.4x ↘	<b>Series</b> 105.0
2: 10.5x ↘	7: 10.6x ↘	
3: 10.5x ←	8: 10.6x ↘	314.3
4: 10.5x ↘	9: 10.8x ↗	
5: 10.6x ←	10: 10.2x ↘	

1: 10.5x ↘	6: 10.5x ↗	<b>Series</b> 105.3
2: 10.5x ↘	7: 10.7x ↖	
3: 10.5x ↗	8: 10.4x →	419.6
4: 10.6x →	9: 10.6x →	
5: 10.6x ↘	10: 10.4x ↗	

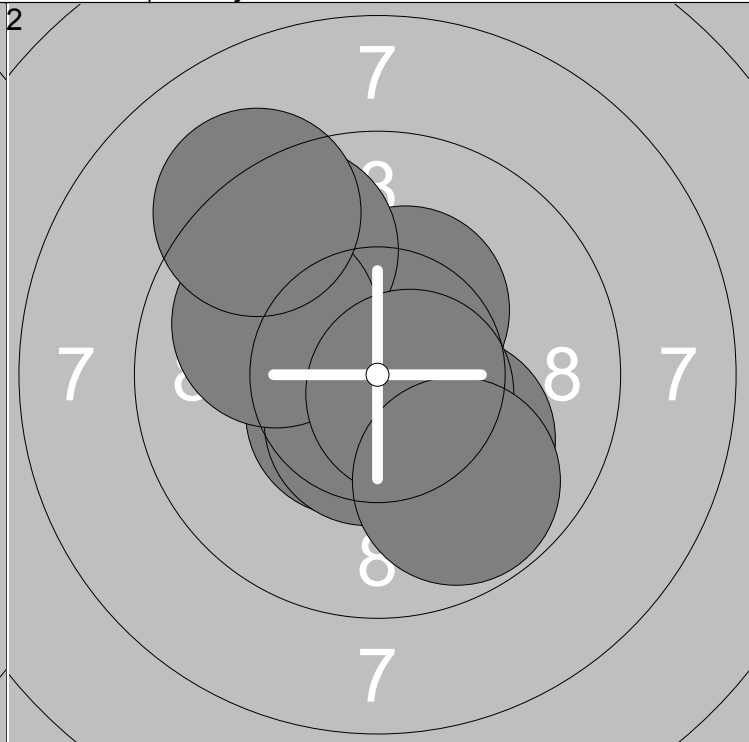
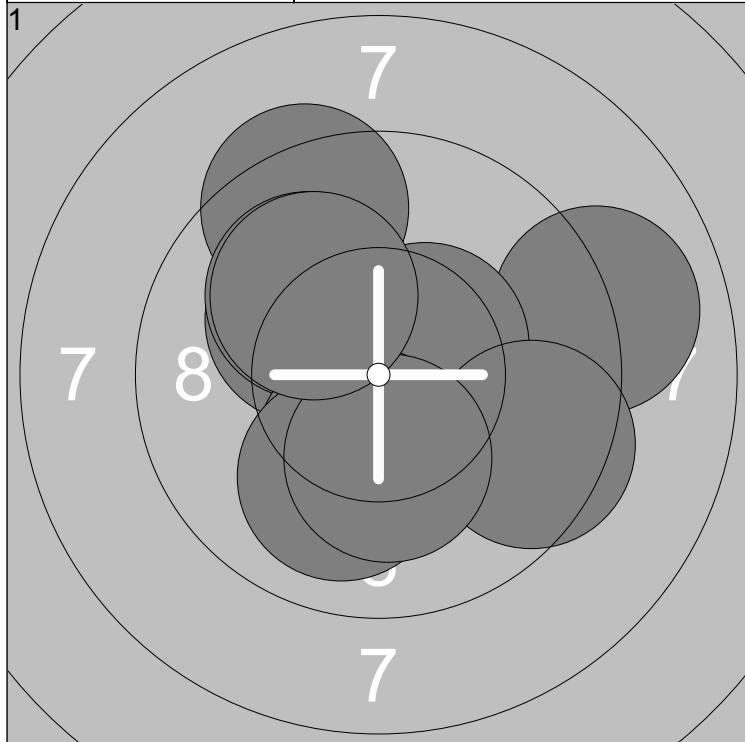

1: 10.2x ↗	6: 10.3x ↓	Series	99.2
2: 9.4 ↗	7: 9.5 →		
3: 10.0 ↗	8: 10.0 ↓	Series	99.2
4: 9.0 →	9: 10.2x ↓		
5: 10.5x ↗	10: 10.1 ↗		

1: 10.2x ↓	6: 9.7 ↗	Series	101.0
2: 10.6x ↘	7: 10.0 ↗		
3: 10.1 ↓	8: 10.6x ↓	Series	200.2
4: 10.5x ↓	9: 9.2 ↗		
5: 10.3x ↗	10: 9.8 ↓		

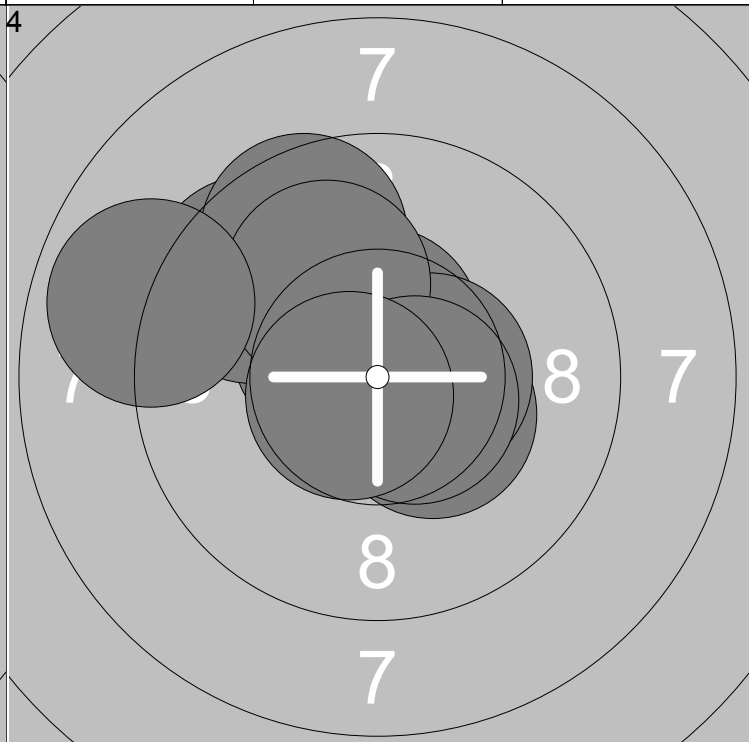
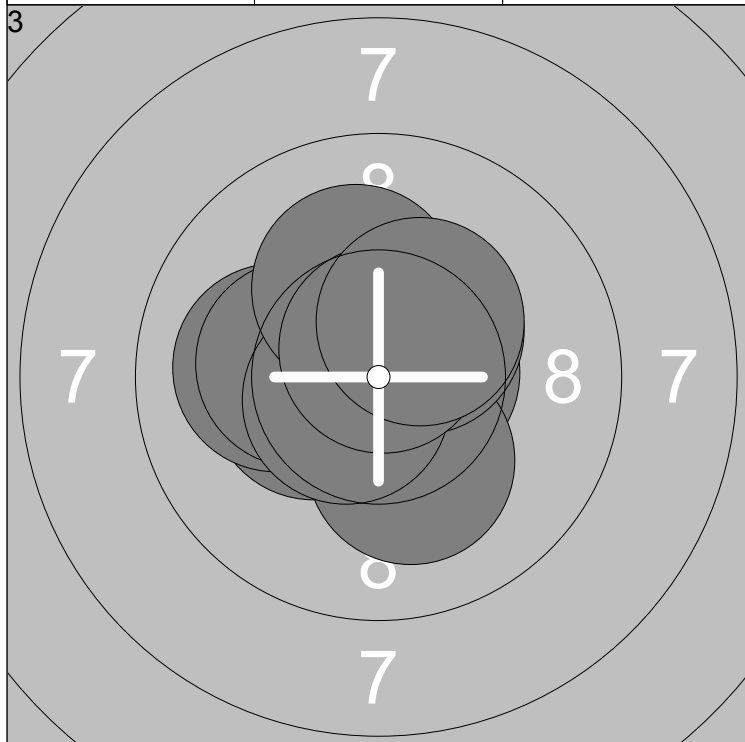

1: 10.6x →	6: 10.6x ↙	Series	103.9
2: 10.4x ←	7: 10.4x ↗		
3: 10.1 ←	8: 10.2x ↑	Series	304.1
4: 10.2x ↓	9: 10.7x ↑		
5: 10.3x ←	10: 10.4x ↗		

1: 10.6x ↑	6: 9.6 ↗	Series	101.5
2: 10.5x ↗	7: 10.1 ↗		
3: 10.4x ↘	8: 8.9 ←	Series	405.6
4: 10.5x →	9: 10.6x ↓		
5: 9.6 ↗	10: 10.7x ↙		



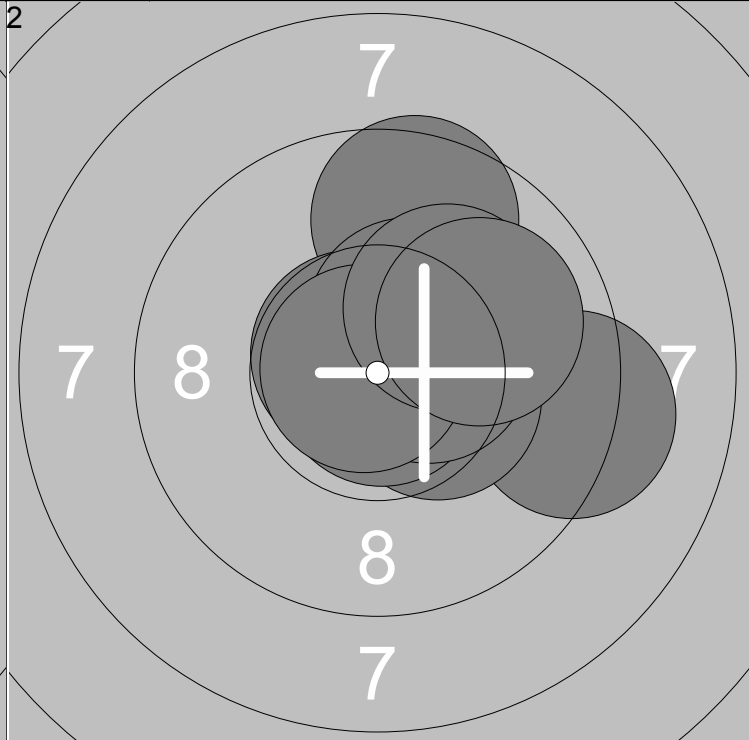
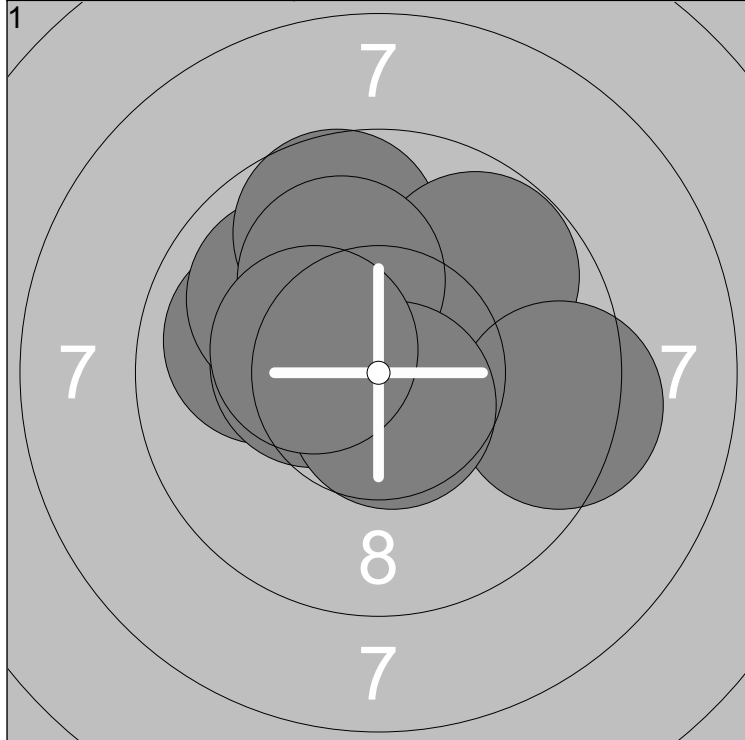

1: 10.7x ↗	6: 9.8 ↗	Series	100.9
2: 9.9 ↖	7: 9.4 →		
3: 10.4x ↖	8: 10.1 ↗	Series	100.9
4: 10.0 ↗	9: 10.6x ↘		
5: 9.7 ↗	10: 10.3x ↖		

1: 9.2 →	6: 10.7x ↖	Series	102.6
2: 10.4x →	7: 10.4x ↗		
3: 10.9x ↘	8: 10.8x ↖	Series	203.5
4: 10.5x →	9: 10.1 ↗		
5: 9.6 ↗	10: 10.0 ↗		

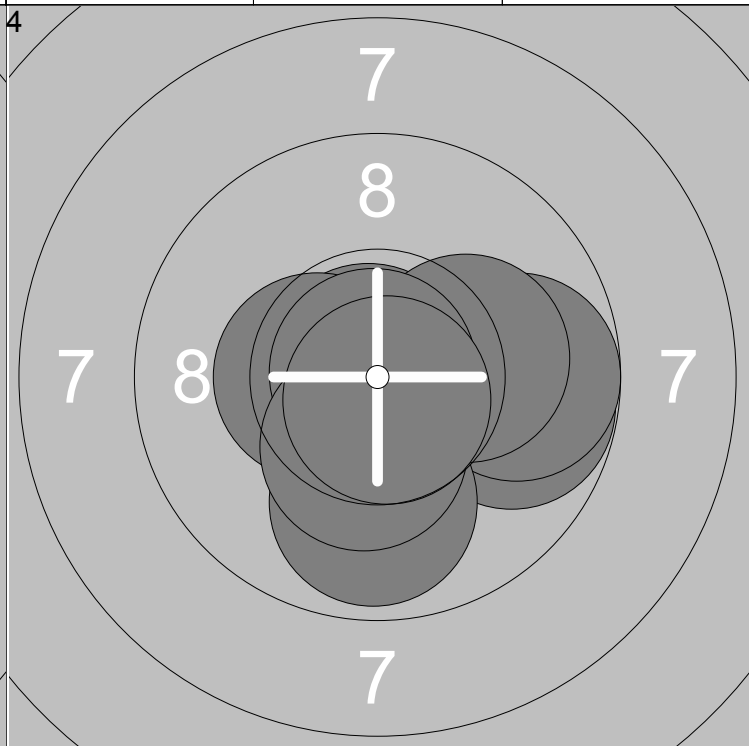
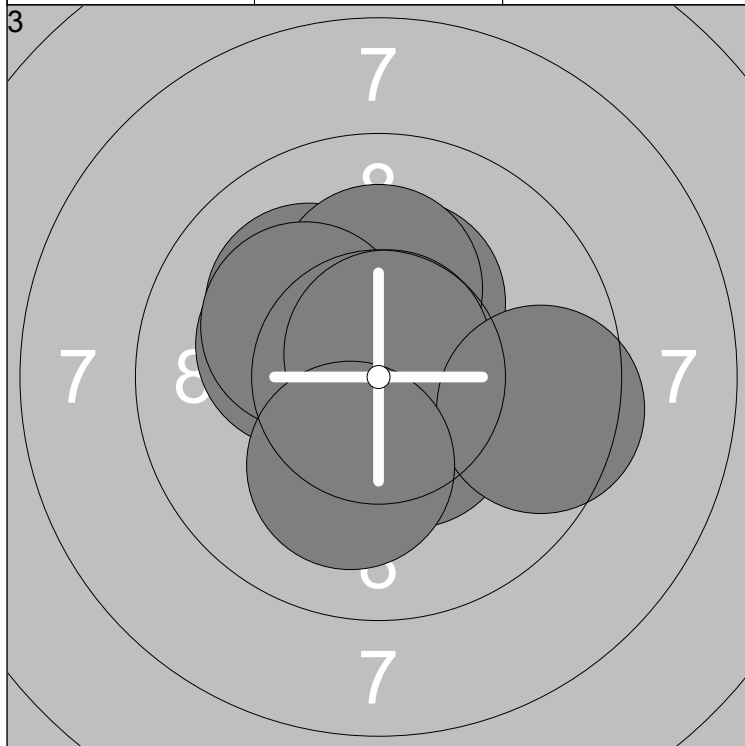

1: 10.2x ↖	6: 10.2x ↗	Series	102.5
2: 10.1 ↗	7: 10.5x ↘		
3: 10.3x ↗	8: 10.7x ↗	Series	306.0
4: 10.6x ↗	9: 9.5 →		
5: 10.2x ↗	10: 10.2x ↘		

1: 9.8 →	6: 10.5x ↘	Series	103.4
2: 10.8x ↗	7: 10.4x ↖		
3: 9.8 →	8: 10.9x ↖	Series	409.4
4: 10.2x →	9: 10.4x ↘		
5: 9.9 ↘	10: 10.7x ↘		

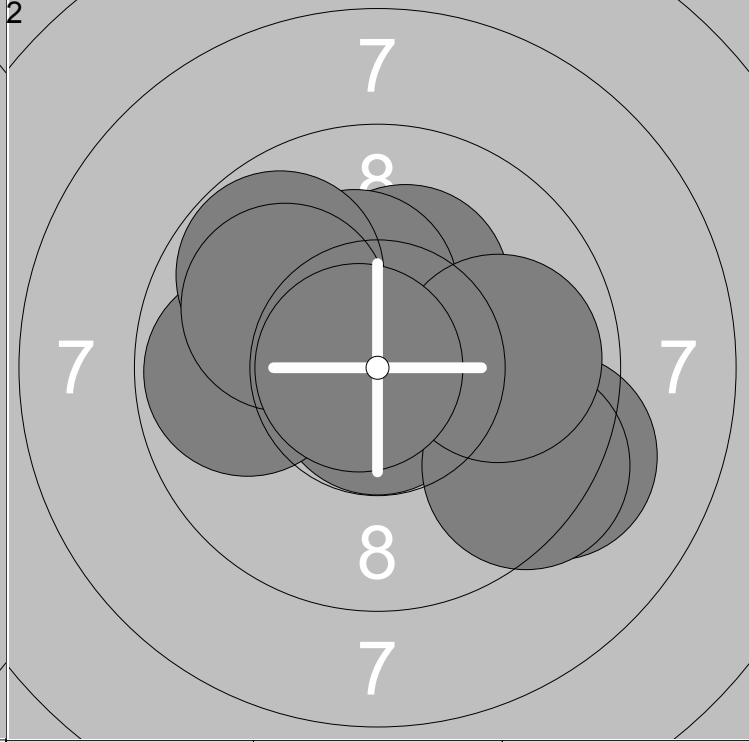
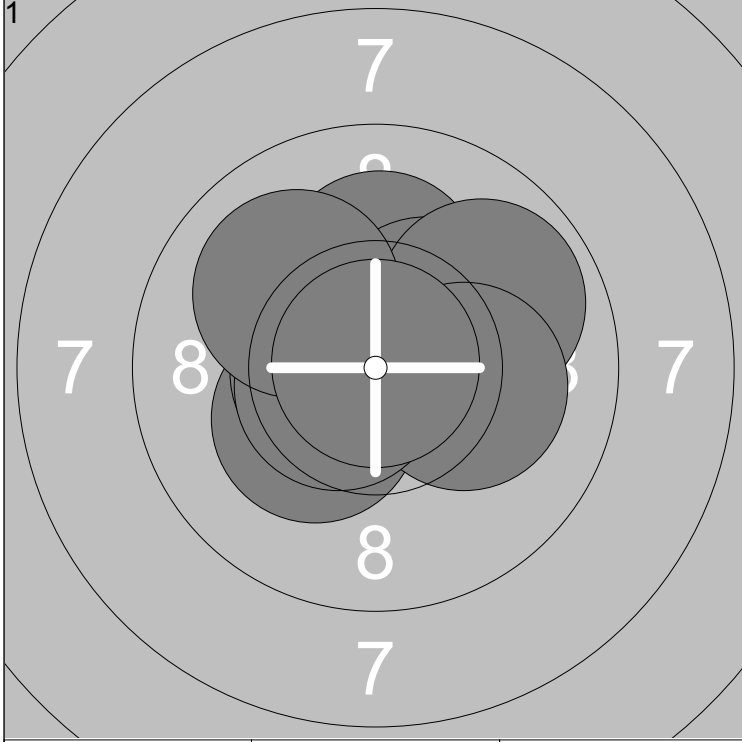

1: 10.3x ↙	6: 10.6x ←	Series	103.7
2: 10.8x ←	7: 10.2x →		
3: 10.1 ↑	8: 10.6x ↙		103.7
4: 10.3x ↗	9: 10.0 ↖		
5: 9.9 ↗	10: 10.9x ↑		

1: 10.2x ↗	6: 9.8 ←	Series	100.2
2: 9.2 →	7: 9.8 ↗		
3: 10.8x ↓	8: 10.0 ↗		203.9
4: 9.4 ↘	9: 9.9 →		
5: 10.3x ↗	10: 10.8x ←		

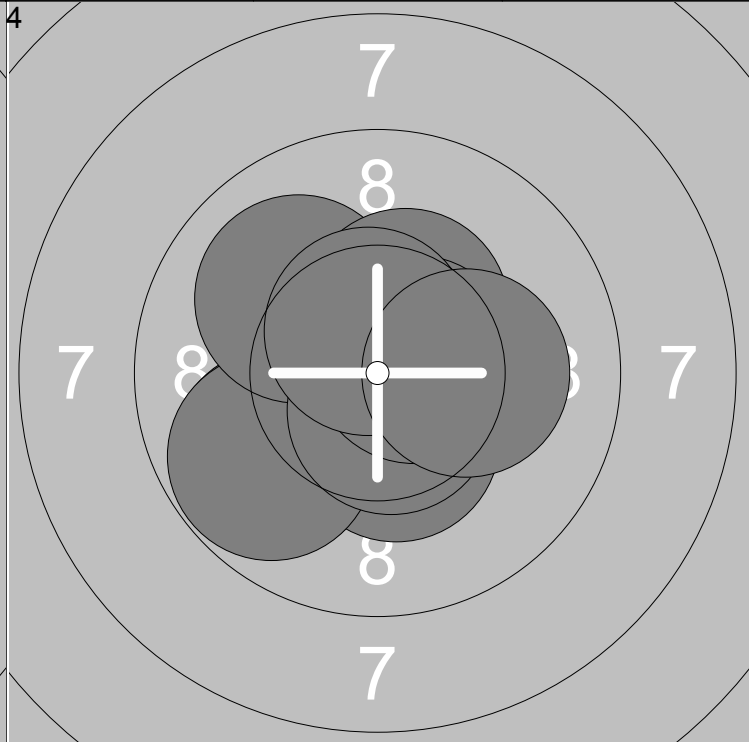
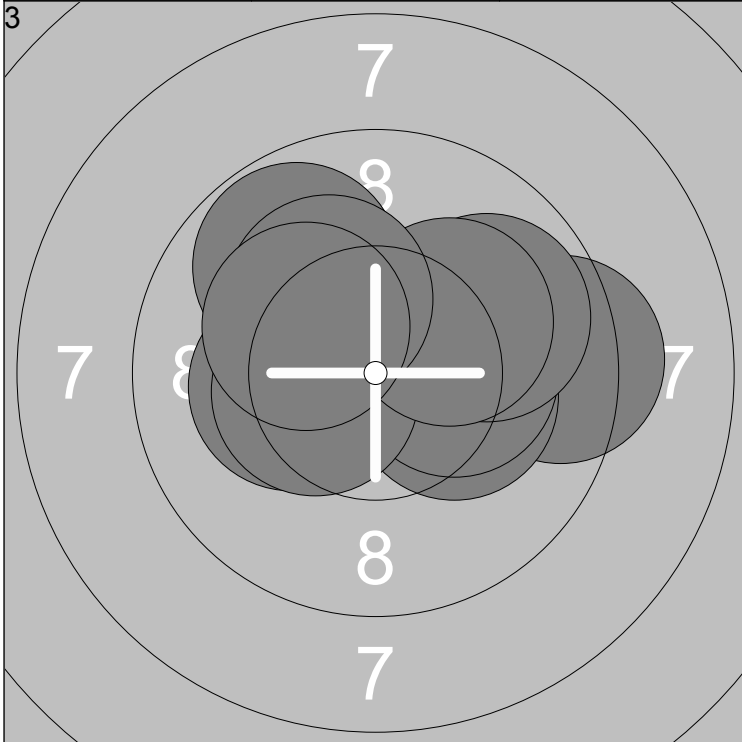

1: 9.4 →	6: 10.4x ←	Series	100.9
2: 10.3x →	7: 10.2x ↗		
3: 10.3x →	8: 9.8 ↗		304.8
4: 10.2x ←	9: 10.2x ↗		
5: 9.9 ↗	10: 10.2x ↖		

1: 9.8 ↙	6: 10.4x ↗	Series	103.1
2: 10.7x ←	7: 10.6x ↓		
3: 10.4x ↓	8: 10.6x →		407.9
4: 9.8 ↙	9: 10.6x ↑		
5: 10.0 ↖	10: 10.2x →		

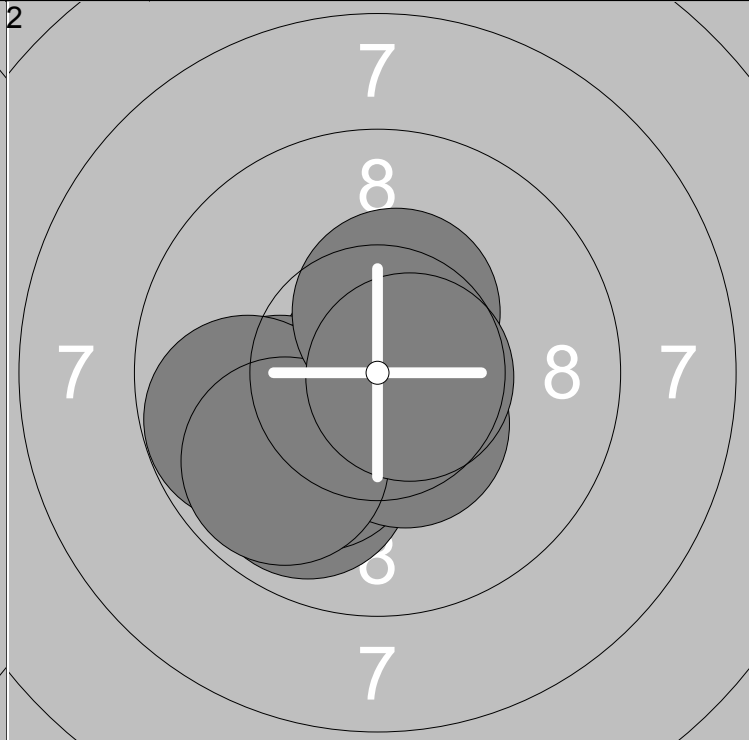
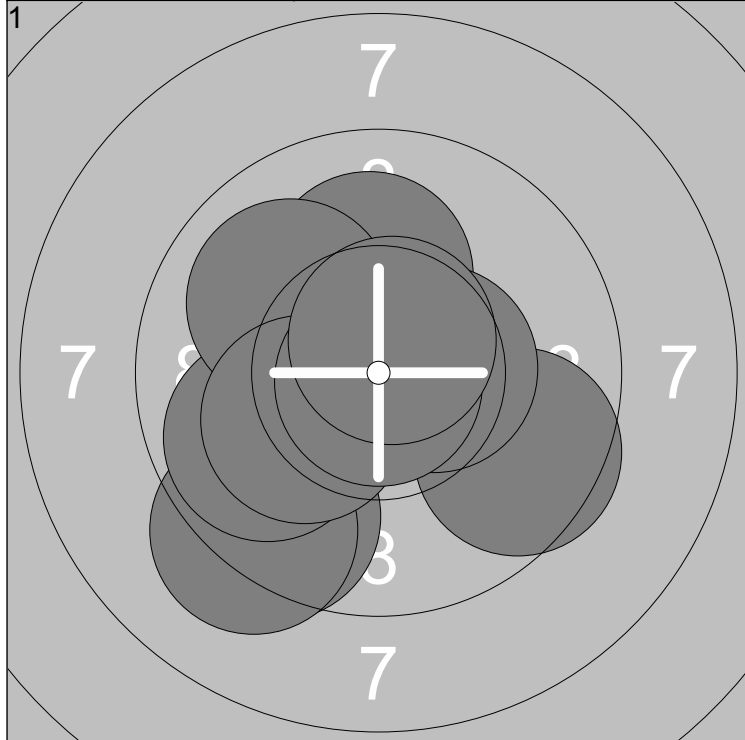

1: 9.4 ↘	6: 9.6 →	Series	100.3
2: 9.2 ↘	7: 10.2x ←		
3: 9.8 ←	8: 10.5x →	Series	100.3
4: 10.1 ↑	9: 10.9x ↓		
5: 10.0 ↖	10: 10.6x ↗		

1: 10.9x	6: 9.8 ←	Series	102.3
2: 10.0 ←	7: 10.5x ↓		
3: 9.9 ↘	8: 9.8 ↙	Series	202.6
4: 10.1 ↘	9: 10.4x ↑		
5: 10.2x ↙	10: 10.7x →		

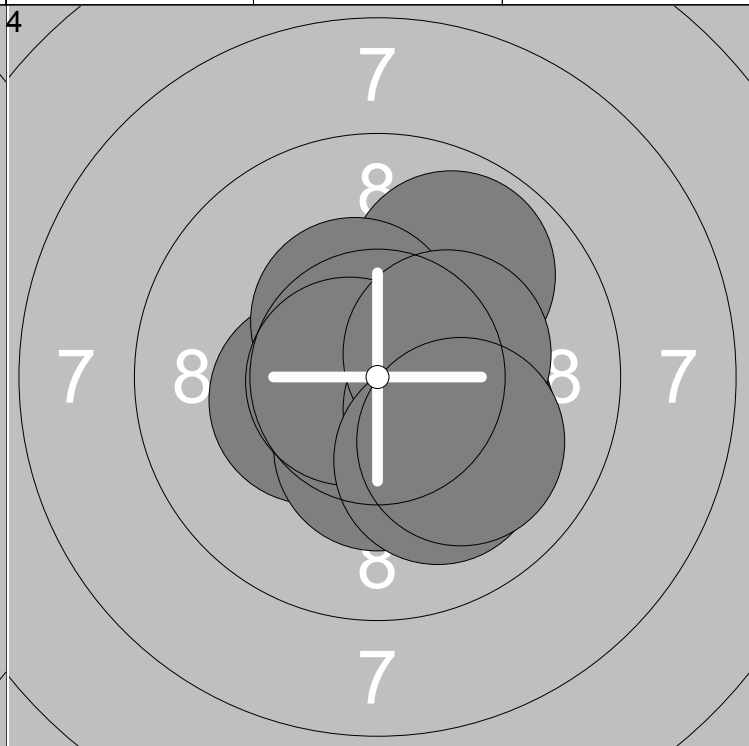
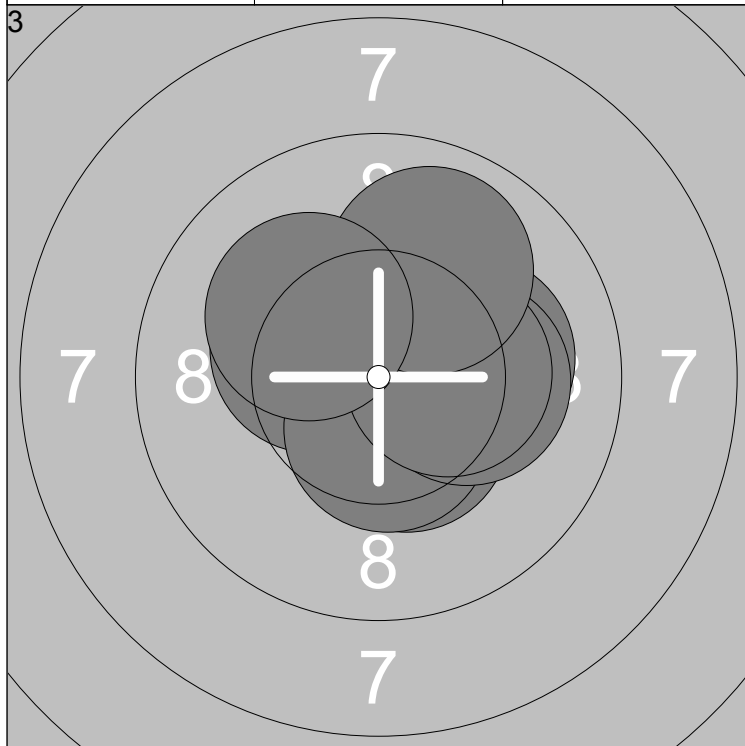

1: 10.7x ↑	6: 10.5x ↓	Series	103.2
2: 10.4x ↖	7: 10.2x →		
3: 10.3x ↗	8: 10.4x →	Series	305.8
4: 10.1 →	9: 9.9 ↗		
5: 10.5x ↓	10: 10.2x ↖		

1: 9.8 ↗	6: 10.7x ←	Series	102.5
2: 10.2x ↘	7: 10.3x ↘		
3: 10.3x ←	8: 10.3x →	Series	408.3
4: 10.4x ↖	9: 10.1 ↓		
5: 10.4x ↓	10: 10.0 ↘		

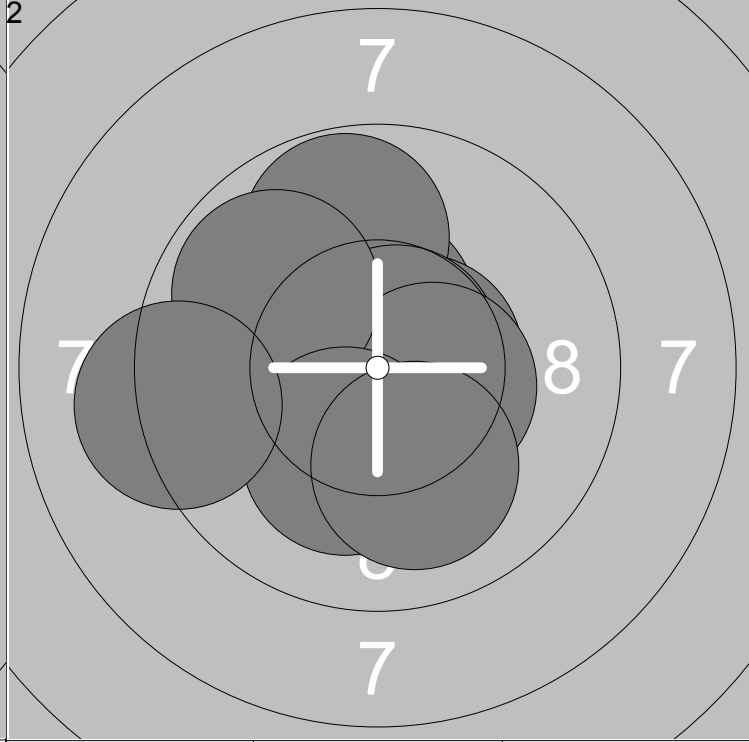
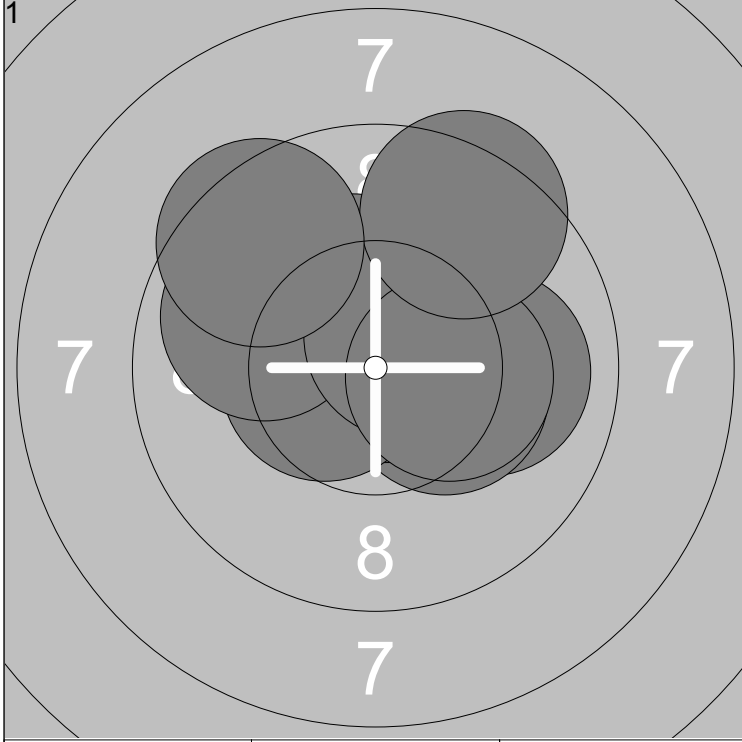

1: 10.0 →	6: 9.9 ←	Series	
2: 10.3x ↗	7: 10.5x ↗		101.5
3: 10.3x →	8: 10.3x →	101.5	
4: 10.8x ↗	9: 9.4 ↗		
5: 10.5x ←	10: 9.5 ↖		

1: 10.5x ↑	6: 10.5x →	Series	
2: 9.8 ↑	7: 9.9 ↖		102.0
3: 10.6x ↓	8: 10.2x ↓	203.5	
4: 10.6x →	9: 10.0 ↓		
5: 10.7x ↗	10: 9.2 ←		

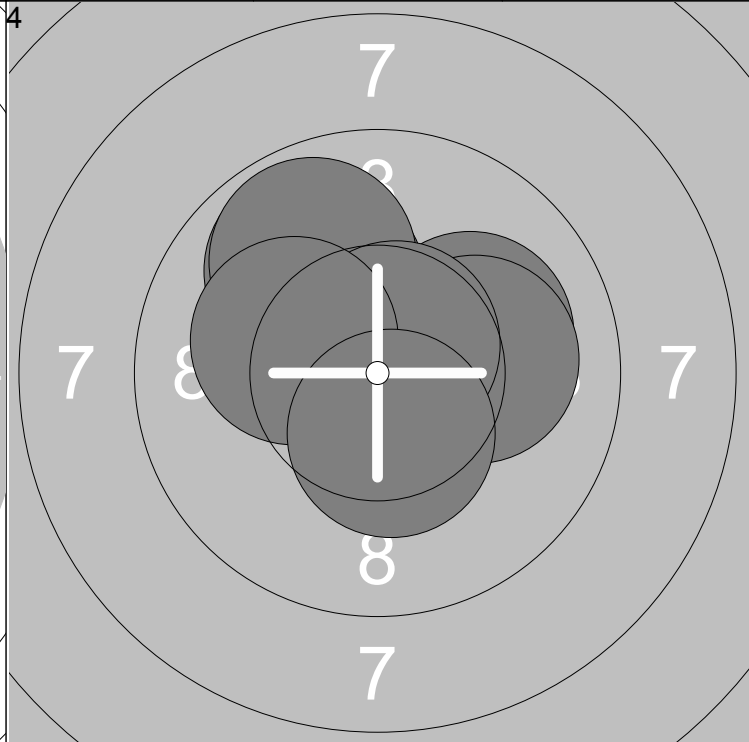
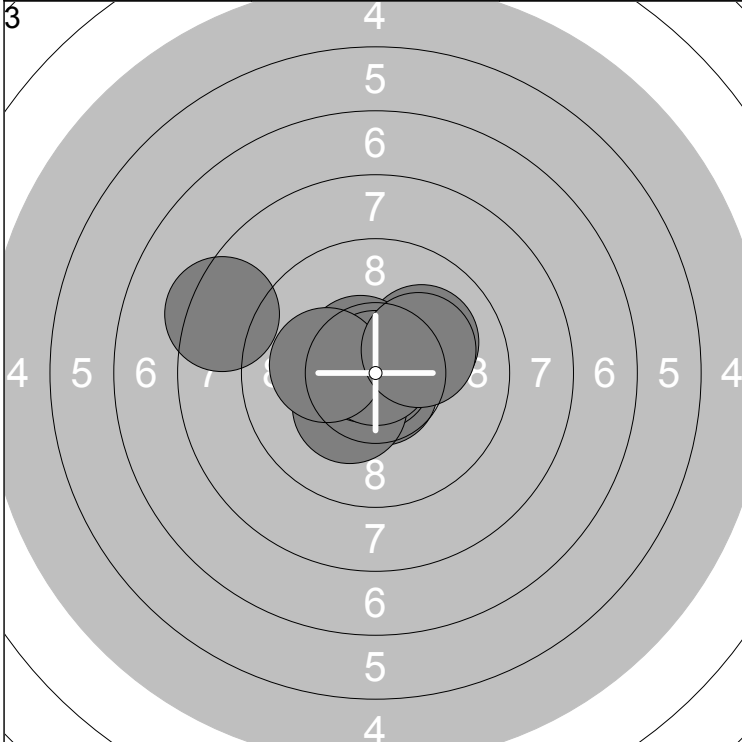

1: 10.7x ↓	6: 10.6x ↗	Series	
2: 10.9x	7: 10.9x ↑		103.1
3: 10.3x ↘	8: 10.2x ←	306.6	
4: 10.8x ↖	9: 8.4 ←		
5: 10.1 ↗	10: 10.2x ↗		

1: 10.5x ↗	6: 10.1 →	Series	
2: 9.9 ↗	7: 10.1 →		101.8
3: 10.0 ↗	8: 10.6x ↗	408.4	
4: 9.8 ↗	9: 10.2x ←		
5: 10.2x →	10: 10.4x ↓		