

1: 10.0 ↓	6: 9.9 ↓	Series	99.7
2: 10.1 ←	7: 9.8 ↗		
3: 10.6x ↙	8: 10.4x ↖	Series	99.7
4: 9.3 ↗	9: 9.6 ↓		
5: 9.6 ↖	10: 10.4x →		

1: 9.8 ↖	6: 9.1 ←	Series	98.7
2: 9.5 ↗	7: 10.0 ←		
3: 9.3 ↗	8: 10.8x ↓	Series	198.4
4: 10.5x ↓	9: 10.1 ↗		
5: 9.5 ↖	10: 10.1 ↗		

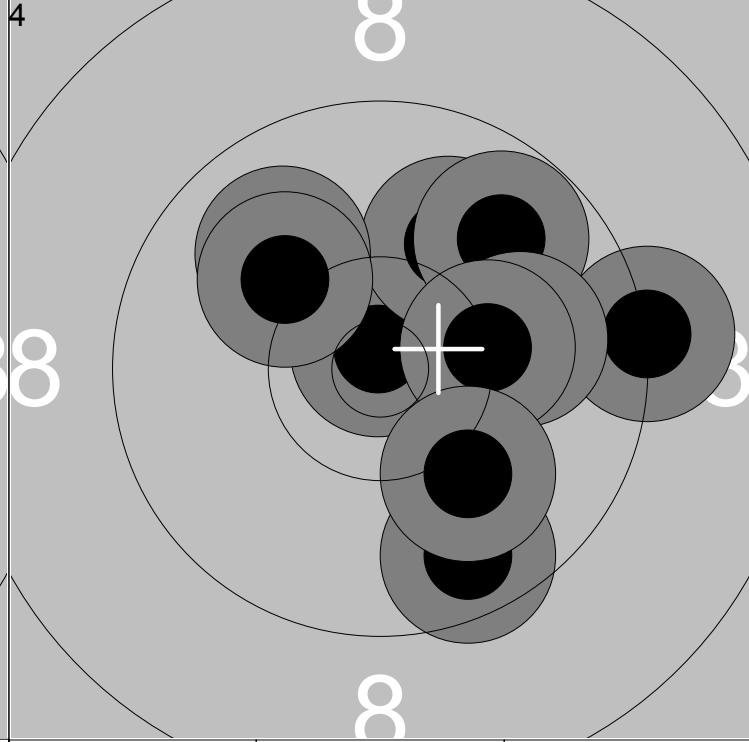
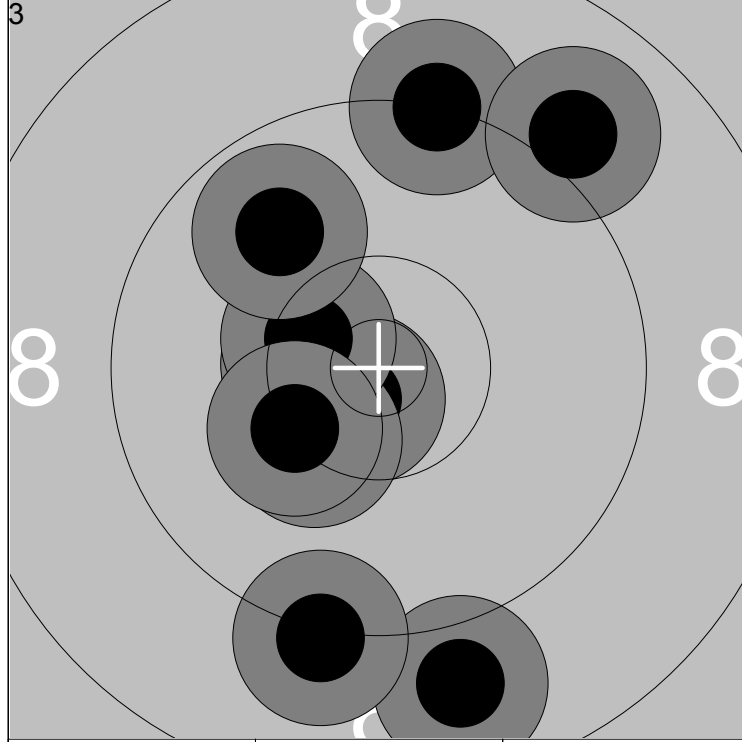

1: 10.5x ←	6: 9.9 ↖	Series	98.5
2: 10.7x ↓	7: 9.2 ↗		
3: 10.3 ↙	8: 9.0 ↗	Series	296.9
4: 10.5x ↖	9: 10.3 ↖		
5: 8.9 ↓	10: 9.2 ↓		

1: 9.6 ↓	6: 10.0 ↗	Series	99.9
2: 9.2 →	7: 10.0 →		
3: 10.8x ↑	8: 10.1 ↖	Series	396.8
4: 10.0 ↗	9: 10.3 →		
5: 9.8 ↗	10: 10.1 ↓		

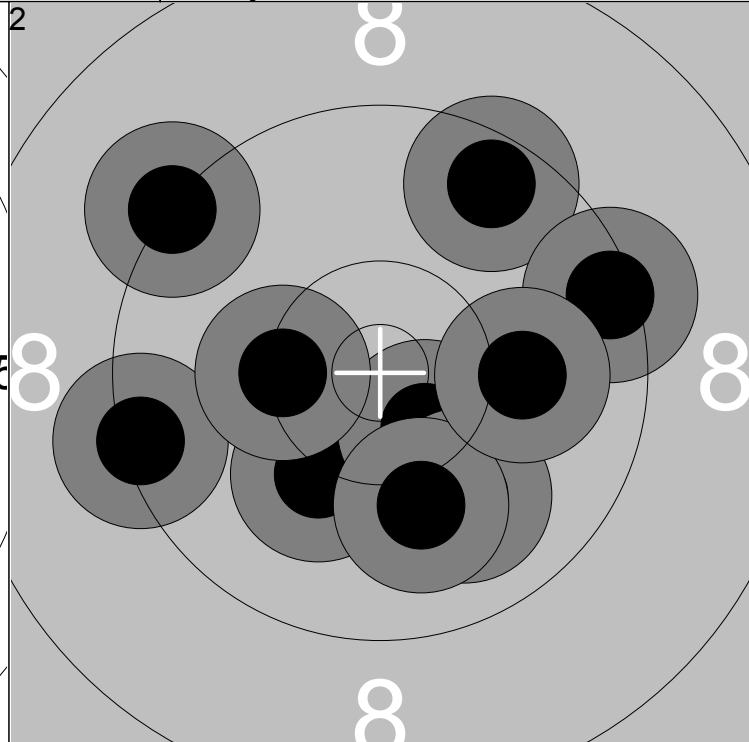
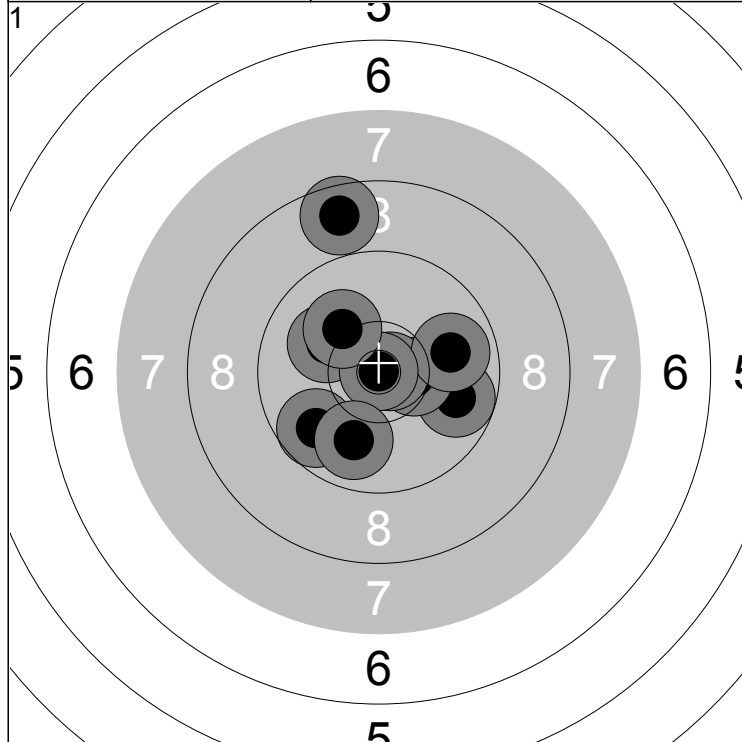

1: 9.8 →	6: 9.8 ↙	<b>Series</b>	100.4
2: 10.1 ↖	7: 9.9 →		
3: 8.7 ↑	8: 10.9x ↑	100.4	
4: 10.4x →	9: 9.9 ↘		
5: 10.8x →	10: 10.1 ↖		

1: 9.4 ←	6: 10.3 ←	<b>Series</b>	98.6
2: 10.2 ↘	7: 10.0 ↘		
3: 9.2 ↖	8: 10.1 ↘	199.0	
4: 9.5 ↗	9: 9.4 →		
5: 10.5x ↘	10: 10.0 →		

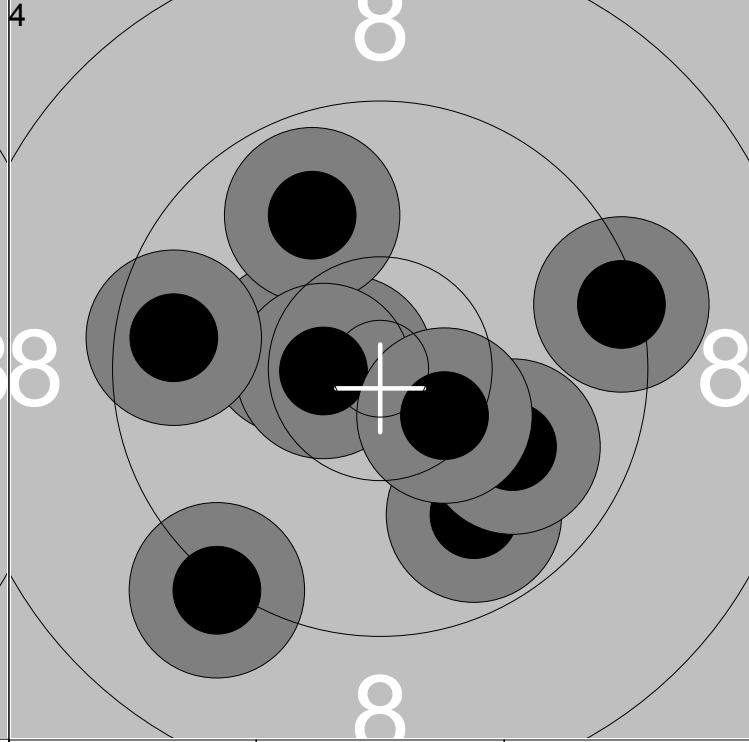
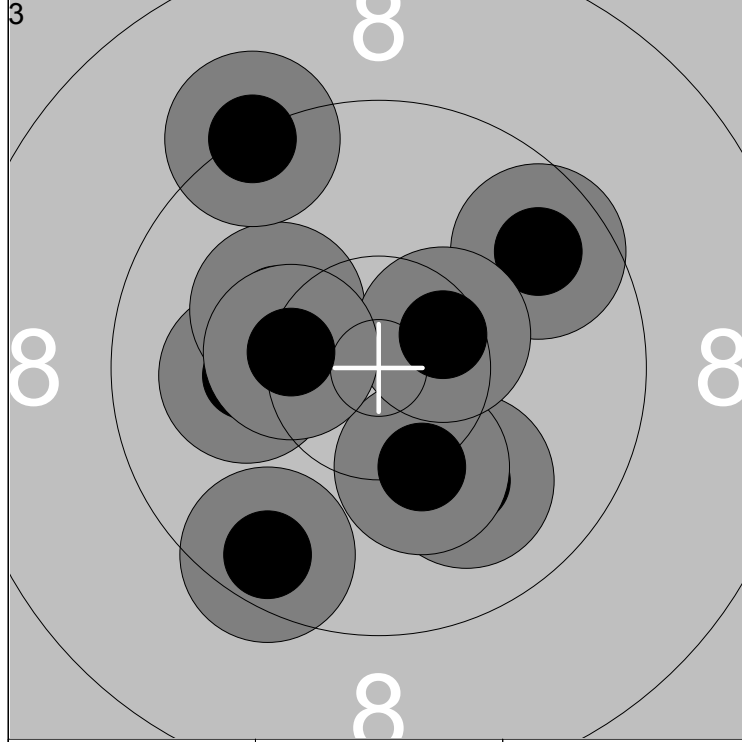

1: 10.1 ←	6: 9.3 ↗	<b>Series</b>	100.2
2: 9.7 ↗	7: 10.0 ↘		
3: 9.5 ↘	8: 10.3 ↘	299.2	
4: 10.2 ↘	9: 10.5x ↗		
5: 10.2 ↖	10: 10.4x ←		

1: 9.2 ↘	6: 9.9 ↗	<b>Series</b>	99.9
2: 10.4x ←	7: 10.0 ↘		
3: 9.3 →	8: 10.6x ←	399.1	
4: 9.8 ↘	9: 10.4x ↘		
5: 10.7x ←	10: 9.6 ←		

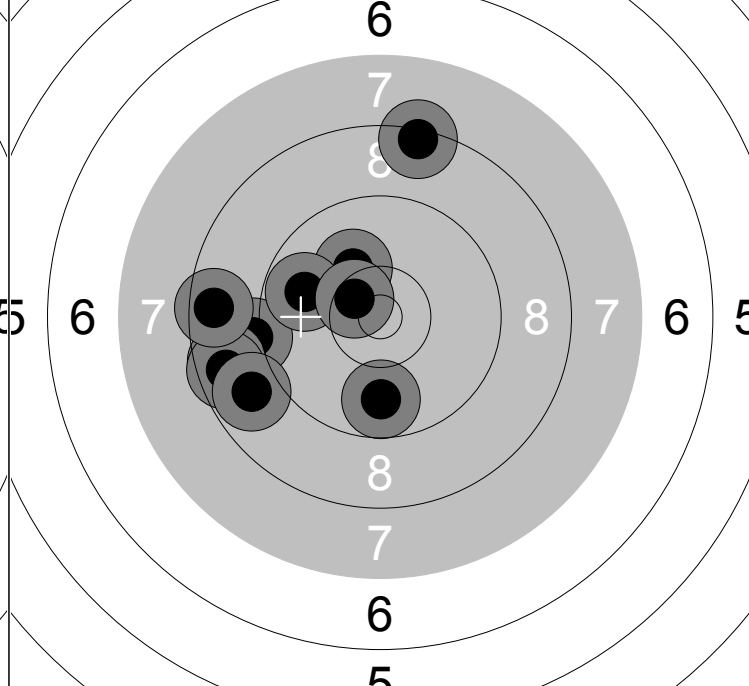
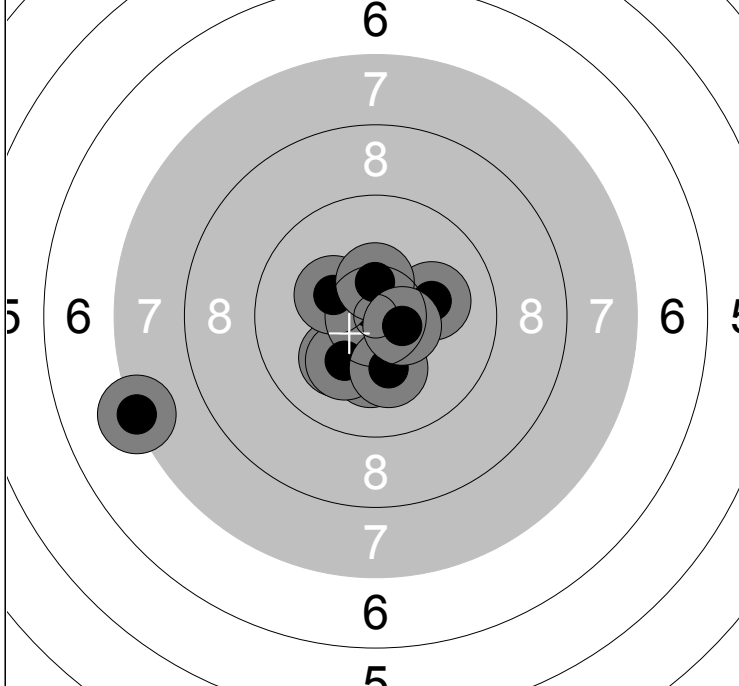

1: 10.2 ↙	6: 10.2 ↓	Series	100.3
2: 10.1 →	7: 10.3 ↖		
3: 10.8x ↗	8: 10.5x ↑	100.3	
4: 10.2 ↓	9: 10.5x →		
5: 10.2 ↘	10: 7.3 ←		

1: 9.8 ↓	6: 10.5x ↖	Series	92.5
2: 10.2 ↗	7: 8.6 ←		
3: 9.1 ←	8: 8.6 ←	192.8	
4: 9.8 ↖	9: 8.8 ↖		
5: 8.7 ←	10: 8.4 ↑		

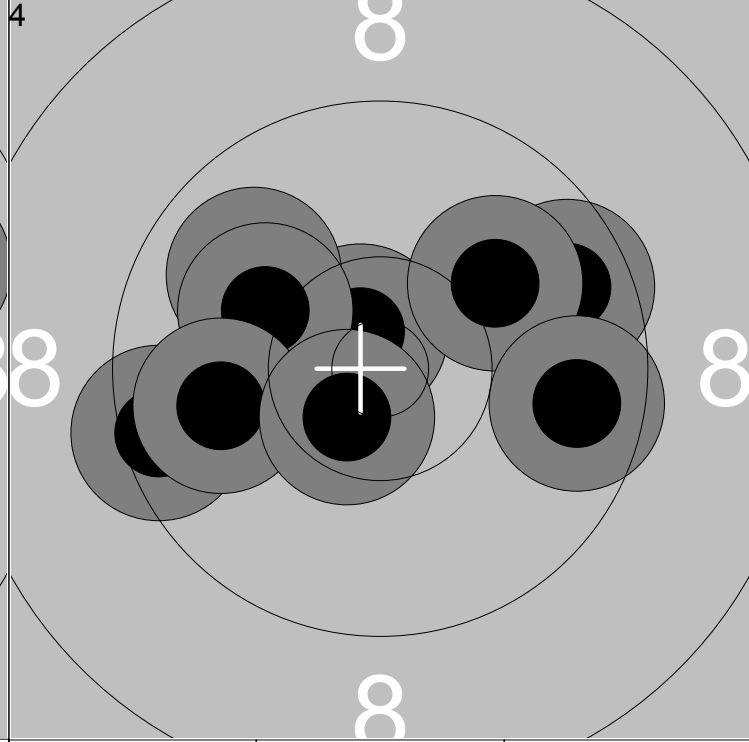
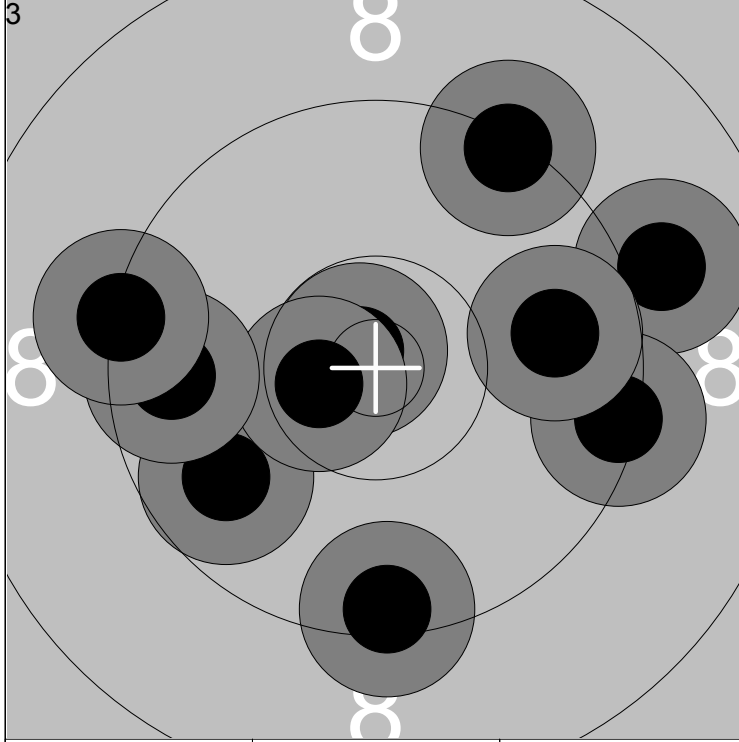

1: 9.3 ↗	6: 10.6x ←	Series	97.0
2: 9.0 →	7: 9.6 ←		
3: 9.8 ↖	8: 9.3 ←	289.8	
4: 9.4 ↓	9: 9.4 →		
5: 10.8x ↖	10: 9.8 →		

1: 9.6 ↗	6: 10.1 ↖	Series	100.6
2: 9.5 ←	7: 9.9 ←		
3: 10.6x ↖	8: 10.0 ↗	390.4	
4: 10.7x ↗	9: 9.7 →		
5: 9.9 ↖	10: 10.6x ↘		

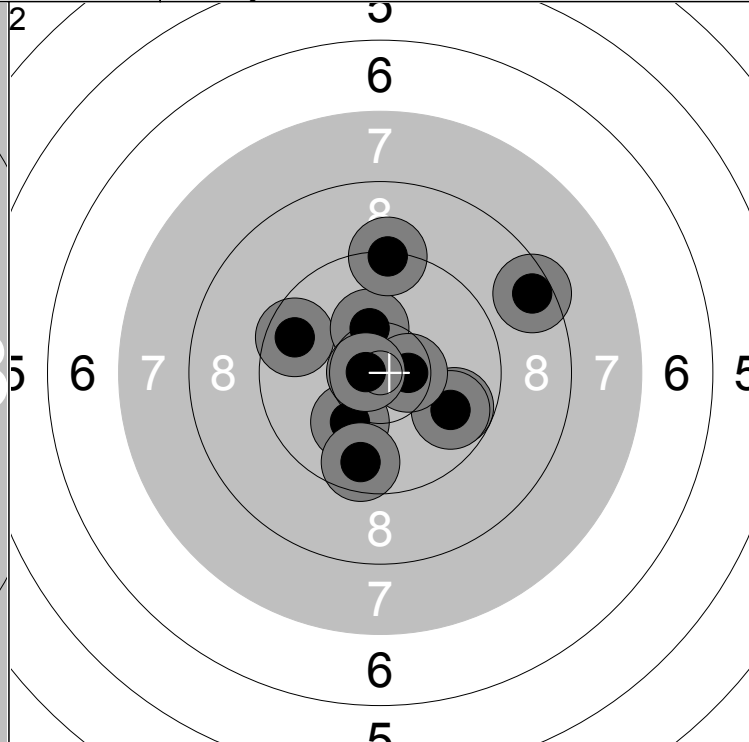
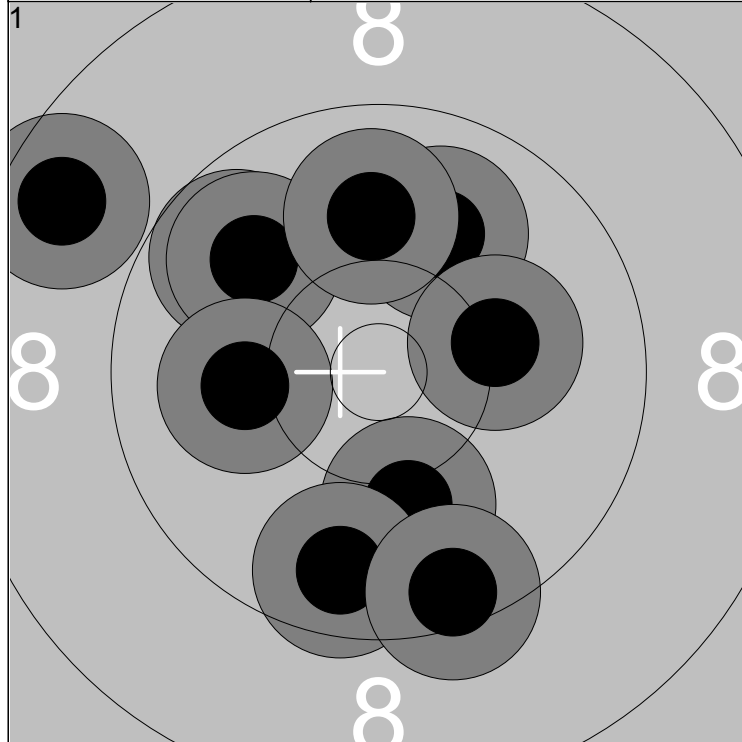

1: 8.6 ↗	6: 9.9 ↑	Series	97.7
2: 9.8 ↗	7: 9.6 ↓		
3: 10.1 ↓	8: 10.2 →	97.7	
4: 9.9 ↗	9: 9.5 ↓		
5: 10.0 ↗	10: 10.1 ←		

1: 9.6 ↖	6: 10.3 ↑	Series	98.4
2: 10.1 ↘	7: 10.6x →		
3: 9.8 →	8: 10.7x ←	196.1	
4: 9.8 ↘	9: 9.3 ↑		
5: 9.7 ↓	10: 8.5 ↗		

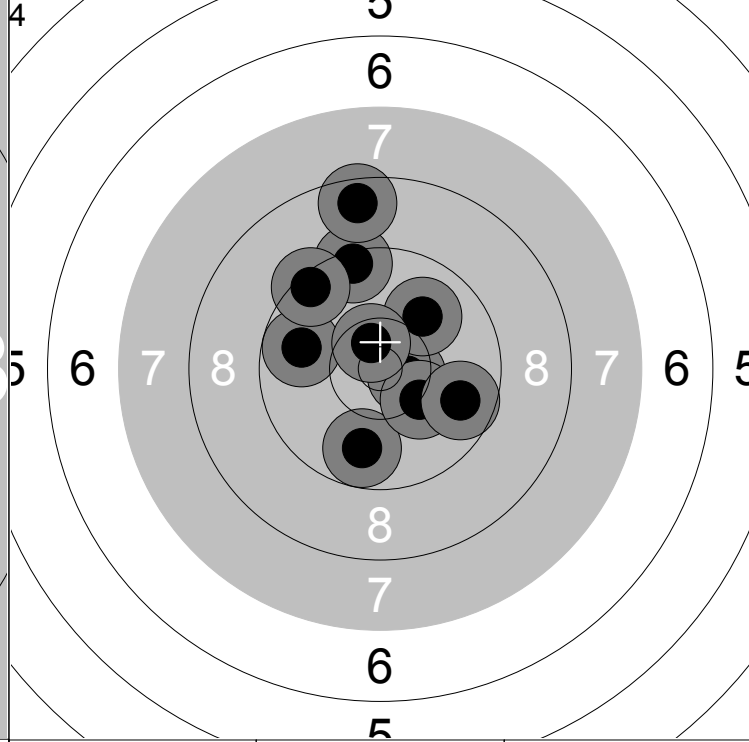
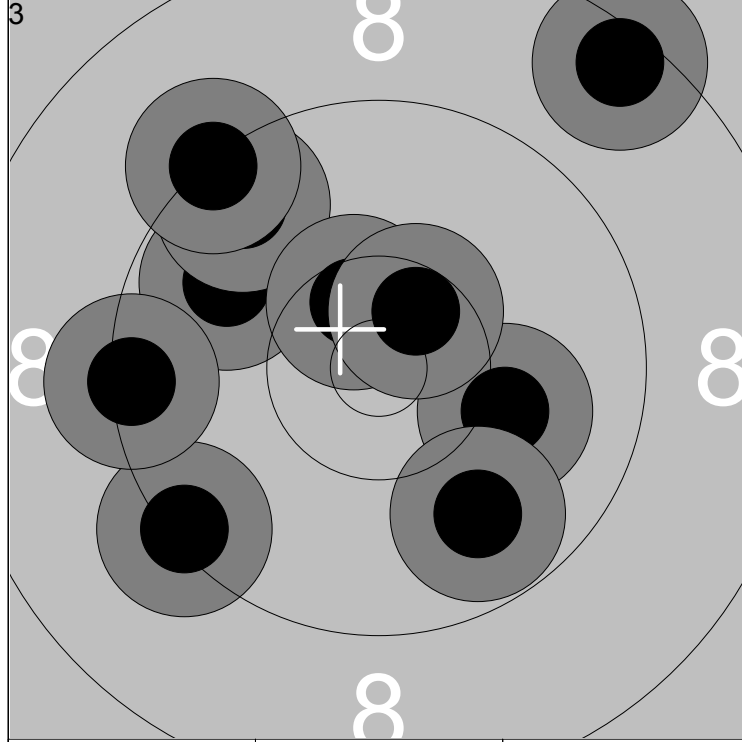

1: 9.8 ↖	6: 9.3 ↖	Series	96.7
2: 9.6 ↗	7: 10.5x ↗		
3: 10.1 →	8: 9.3 ↗	292.8	
4: 8.4 ↗	9: 9.4 ←		
5: 10.5x ↗	10: 9.8 ↓		

1: 9.8 ↓	6: 10.0 ↗	Series	98.1
2: 9.8 ↖	7: 10.6x ↗		
3: 10.6x →	8: 9.7 →	390.9	
4: 10.2 ↘	9: 9.4 ↖		
5: 9.4 ↑	10: 8.6 ↑		

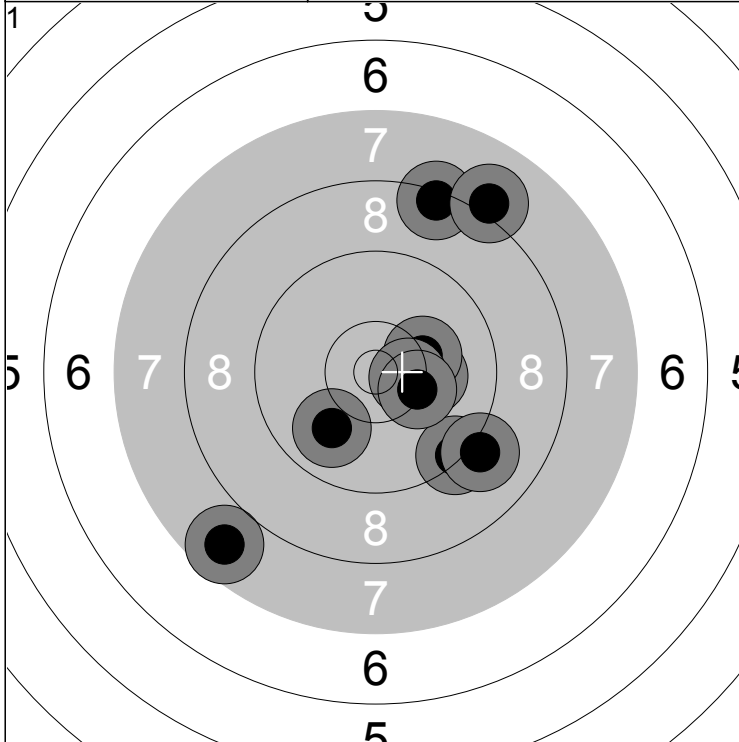

1: 7.7 ↙	6: 9.3 ↘	Series	93.7
2: 10.2 →	7: 10.3 ↘		
3: 10.2 →	8: 9.9 ↘	93.7	
4: 8.4 ↑	9: 9.1 ↘		
5: 10.5x →	10: 8.1 ↗		

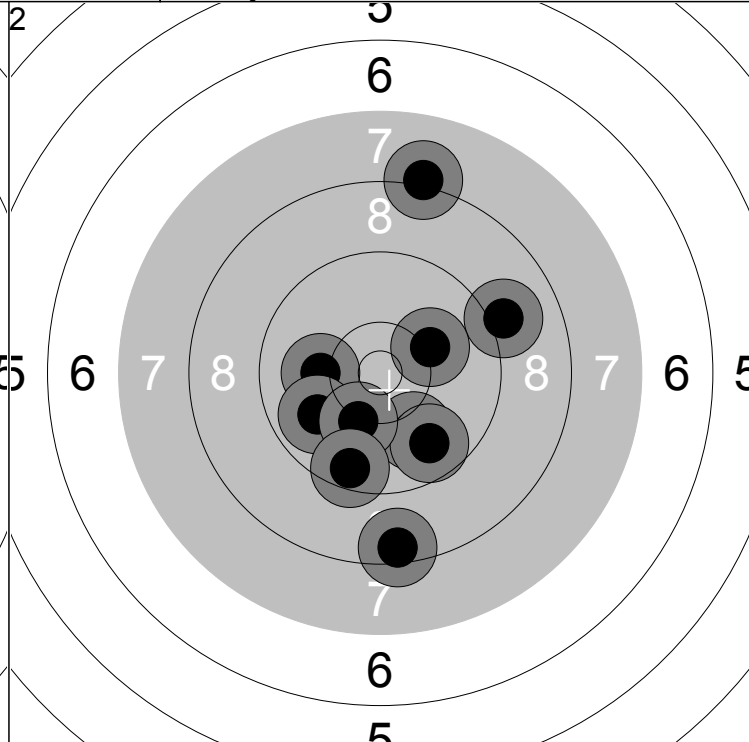

1: 10.0 ↘	6: 9.7 ↘	Series	95.2
2: 10.1 ←	7: 8.5 ↓		
3: 8.1 ↑	8: 10.2 ↓	188.9	
4: 9.9 ↙	9: 9.5 ↓		
5: 9.0 ↗	10: 10.2 ↗		

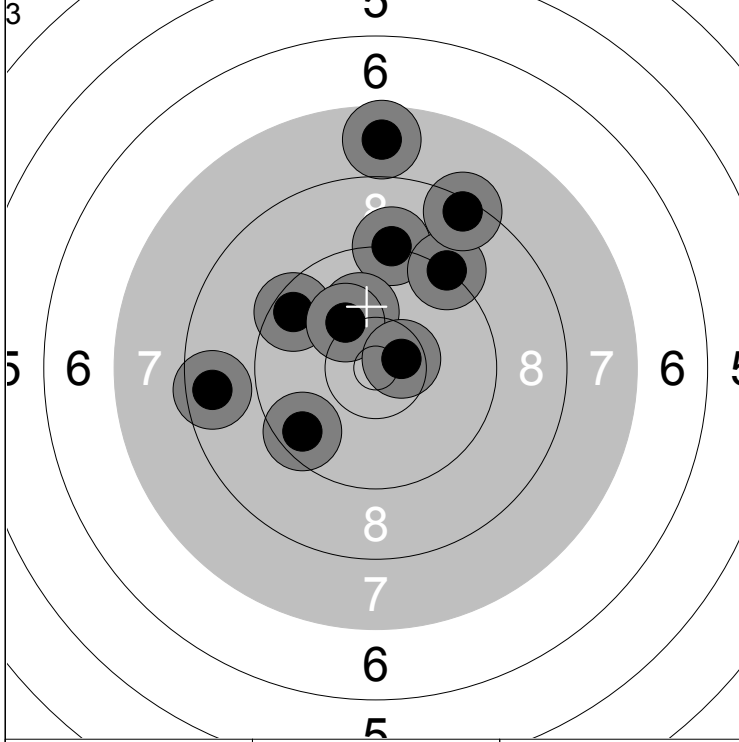

1: 8.6 ←	6: 7.7 ↑	Series	93.1
2: 9.2 ↑	7: 9.6 ↙		
3: 10.1 ↑	8: 10.2 ↖	282.0	
4: 9.2 ↗	9: 10.6x →		
5: 9.5 ↖	10: 8.4 ↗		

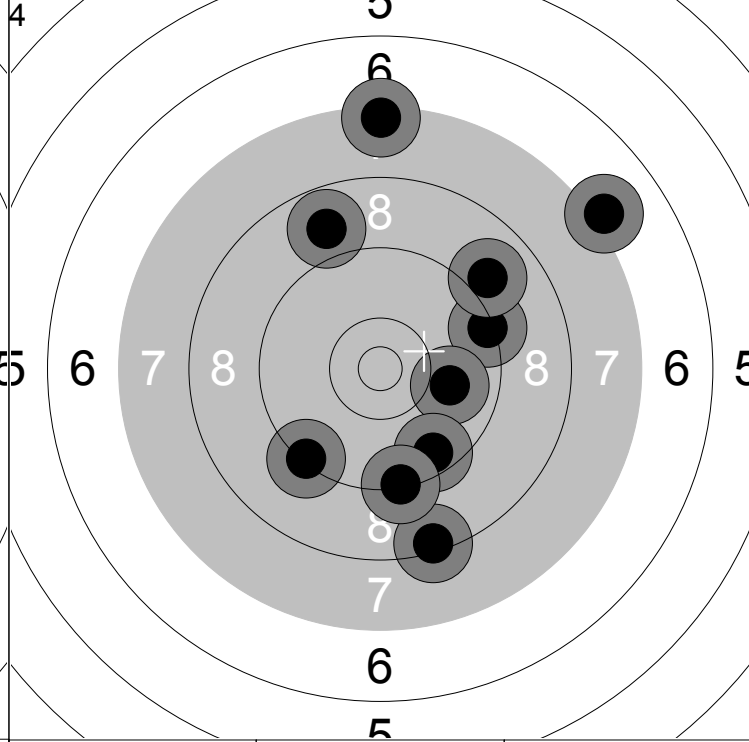

1: 7.4 ↑	6: 9.5 ↓	Series	88.0
2: 7.1 ↗	7: 9.3 ↙		
3: 8.8 ↖	8: 9.0 ↗	370.0	
4: 9.3 ↗	9: 8.4 ↓		
5: 9.9 →	10: 9.3 ↓		

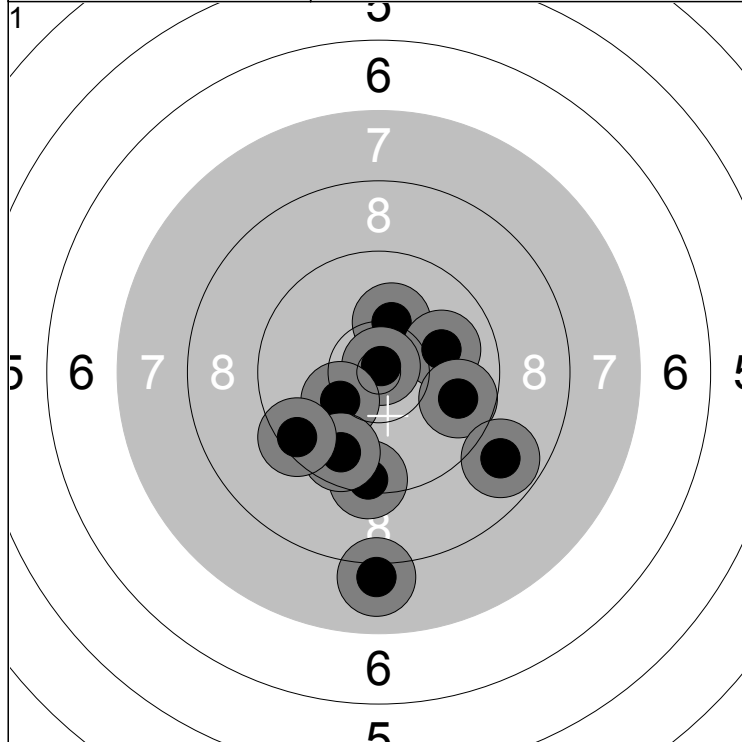

1: 10.2 ↑	6: 9.8 →	<b>Series</b>	96.6
2: 9.4 ↓	7: 10.3 ↙		
3: 10.0 →	8: 9.7 ↓	<b>Series</b>	96.6
4: 10.9x ↑	9: 8.8 ↘		
5: 8.0 ↓	10: 9.5 ↙		

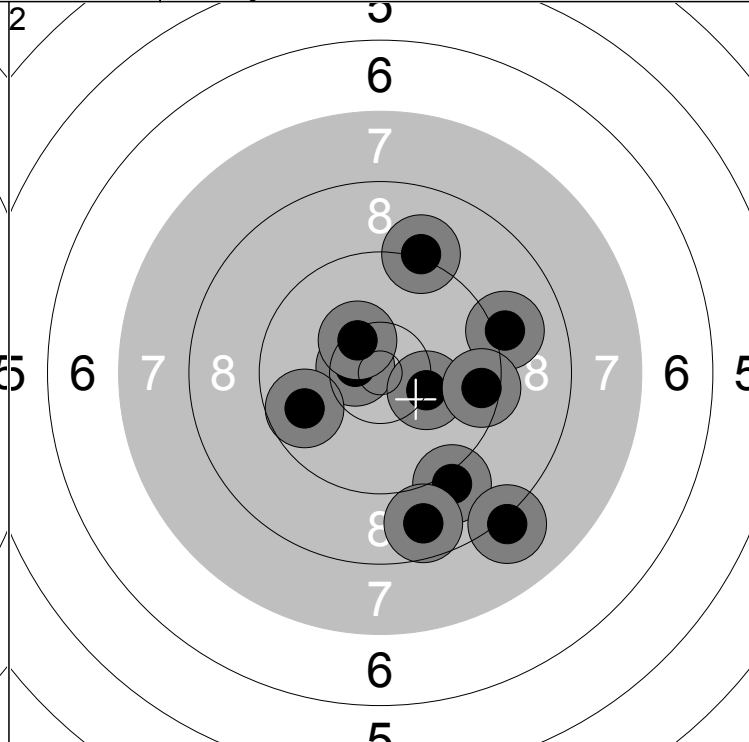

1: 10.6x ←	6: 8.7 ↓	<b>Series</b>	94.8
2: 9.1 →	7: 9.5 →		
3: 9.1 ↘	8: 8.1 ↓	<b>Series</b>	191.4
4: 10.4x ↑	9: 9.2 ↑		
5: 10.3 →	10: 9.8 ←		

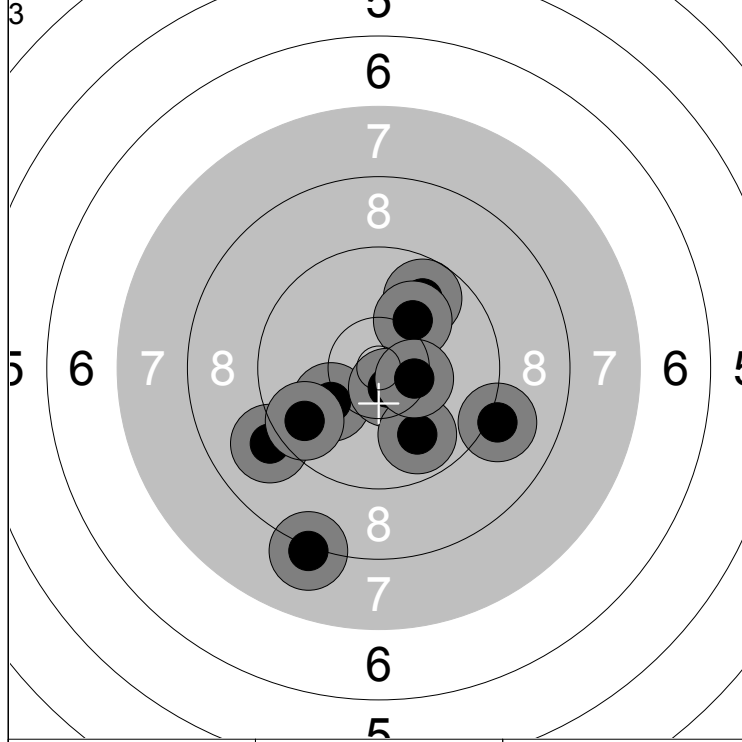

1: 10.1 ↙	6: 9.8 ↗	<b>Series</b>	97.0
2: 9.1 ↙	7: 10.1 ↗		
3: 9.1 →	8: 10.6x ↓	<b>Series</b>	288.4
4: 8.2 ↓	9: 9.9 ↓		
5: 9.7 ↙	10: 10.4x →		

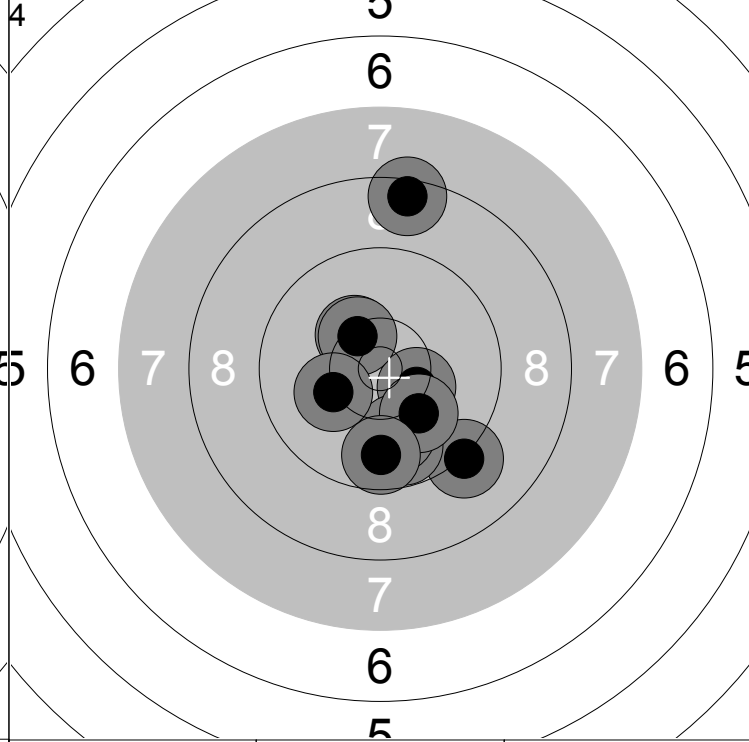

1: 9.2 ↓	6: 10.1 ↓	<b>Series</b>	98.6
2: 10.4x ↘	7: 10.4x ↗		
3: 9.8 ↓	8: 10.2 ↙	<b>Series</b>	387.0
4: 10.3 ↗	9: 8.5 ↑		
5: 10.0 ↓	10: 9.7 ↓		

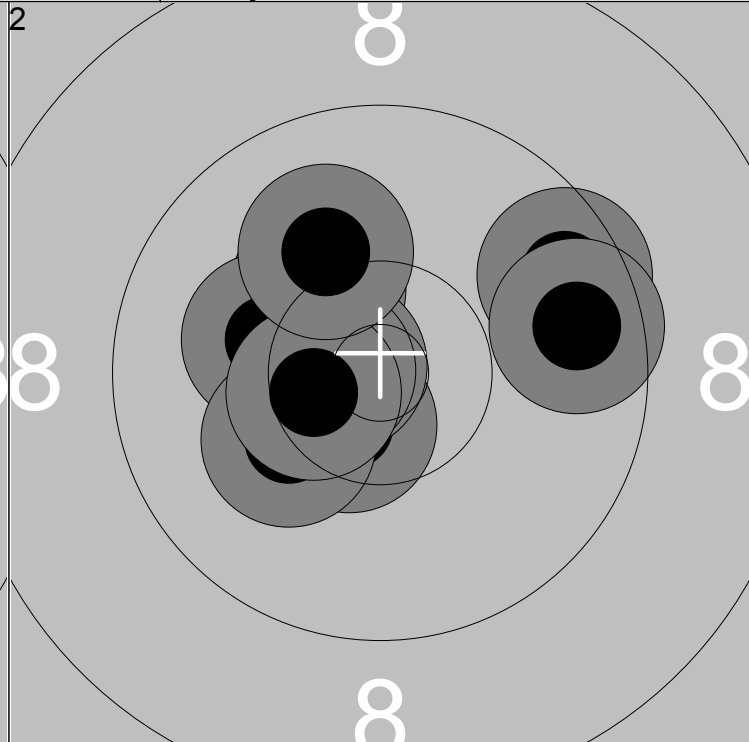
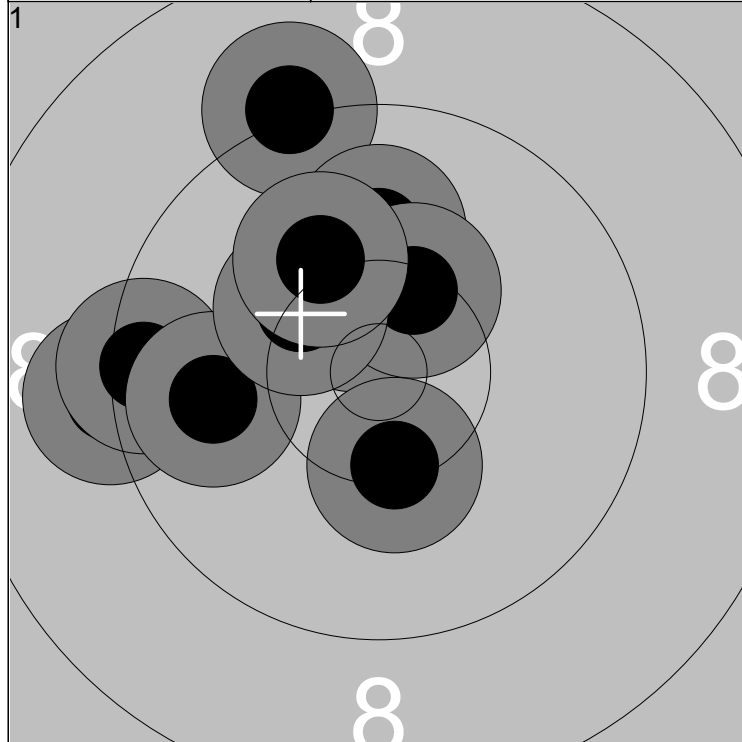

1: 9.2 ↗	6: 9.4 ←	Series	99.4
2: 10.5x ↗	7: 9.9 ←		
3: 9.2 ←	8: 10.4x ↗	99.4	
4: 10.3 ↓	9: 10.3 ↖		
5: 10.1 ↑	10: 10.1 ↖		

1: 10.6x ↘	6: 10.2 ←	Series	102.4
2: 10.3 ↗	7: 10.2 ↘		
3: 10.7x ←	8: 9.6 →	201.8	
4: 9.6 ↗	9: 10.5x ←		
5: 10.6x ←	10: 10.1 ↗		

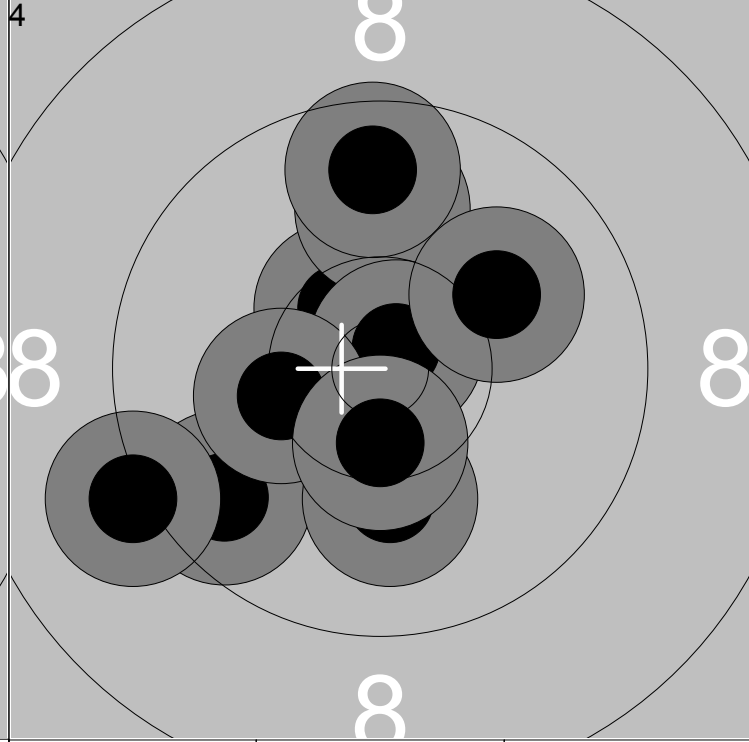
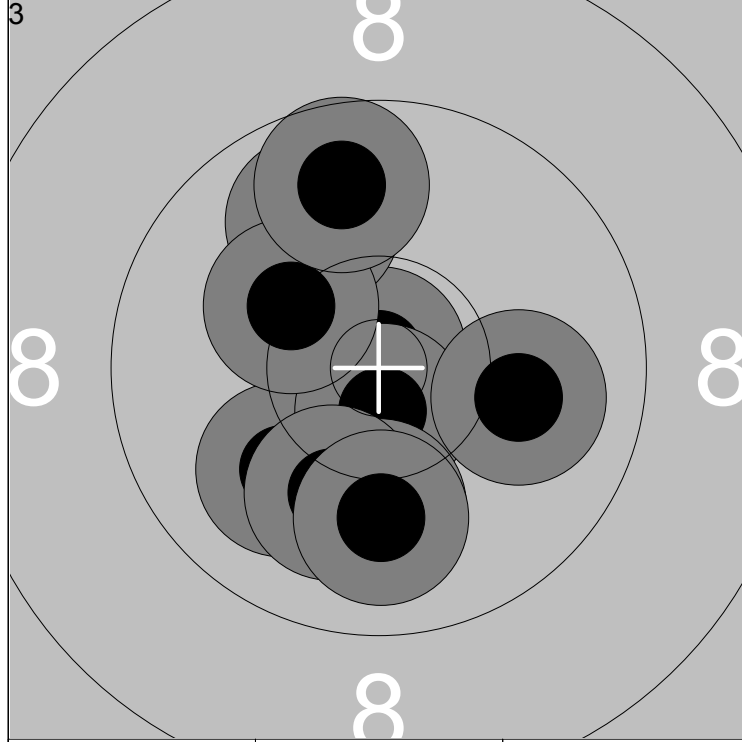

1: 10.9x ↑	6: 10.3 ↗	Series	101.8
2: 10.1 ↘	7: 10.0 →		
3: 9.9 ↗	8: 10.1 ↓	303.6	
4: 10.7x ↓	9: 9.7 ↑		
5: 10.1 ↓	10: 10.0 ↓		

1: 10.5x ↖	6: 10.3 ←	Series	100.7
2: 9.6 ↘	7: 9.7 ↑		
3: 9.9 ↑	8: 10.5x ↓	404.3	
4: 10.1 ↓	9: 10.1 ↗		
5: 10.8x ↗	10: 9.2 ←		

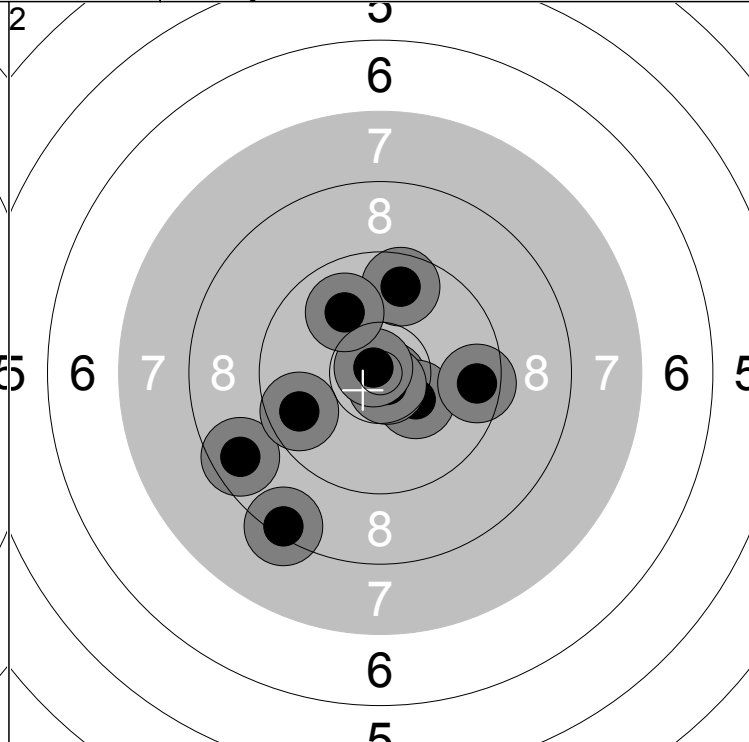
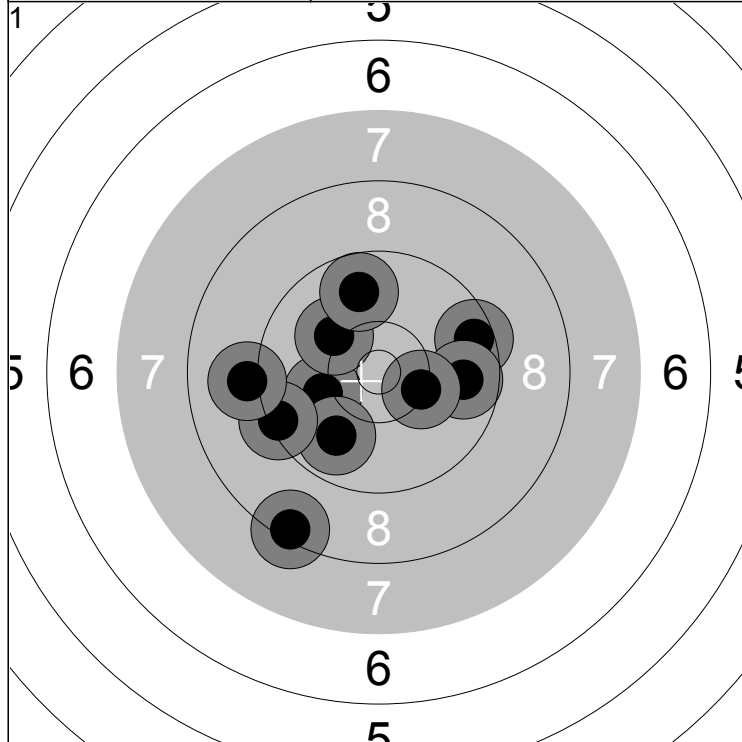

1: 9.5 →	6: 10.1 ↗	Series	96.3
2: 10.1 ←	7: 8.4 ↘		
3: 9.9 ↘	8: 9.8 ↗		
4: 9.4 ←	9: 10.3 ↘		
5: 9.7 →	10: 9.1 ←		
		96.3	

1: 10.8x ↘	6: 10.8x ↗	Series	98.7
2: 10.3 ↘	7: 9.6 →		
3: 8.6 ←	8: 9.7 ↗		
4: 10.8x ↘	9: 10.0 ↗		
5: 9.7 ←	10: 8.4 ↘		
		195.0	

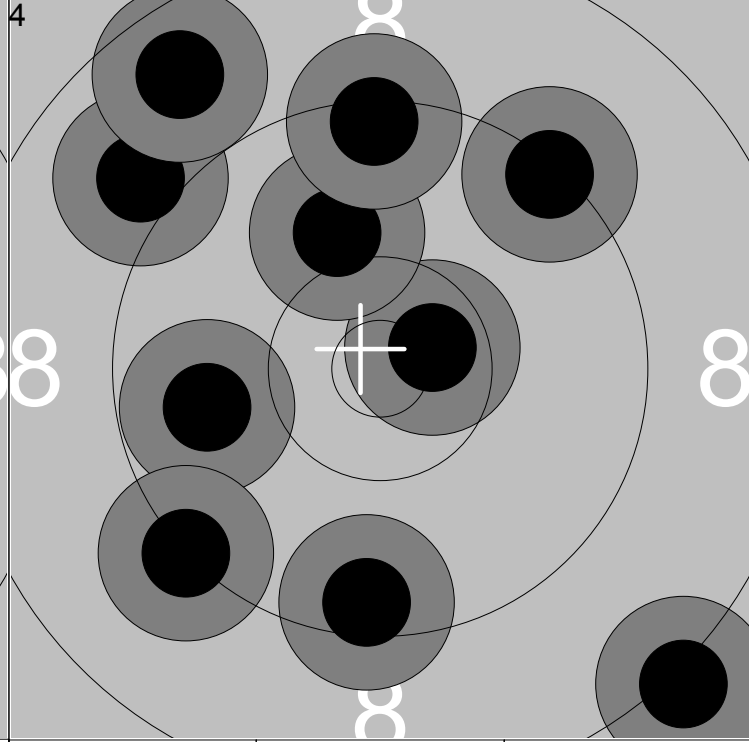
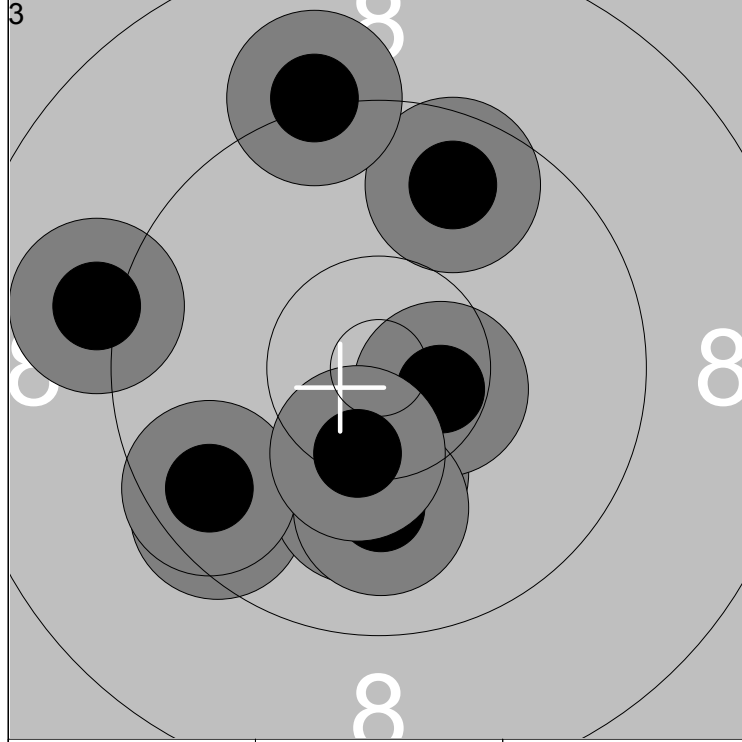

1: 9.6 ↘	6: 9.1 ←	Series	98.6
2: 9.7 ↗	7: 9.2 ↗		
3: 10.3 ↘	8: 10.1 ↘		
4: 10.1 ↘	9: 9.6 ←		
5: 10.5x →	10: 10.4x ↘		
		293.6	

1: 9.8 ←	6: 8.1 ↘	Series	93.5
2: 10.6x →	7: 10.0 ↗		
3: 9.4 ↘	8: 9.0 ↗		
4: 9.2 ↘	9: 9.4 ↗		
5: 9.3 ↗	10: 8.7 ↗		
		387.1	



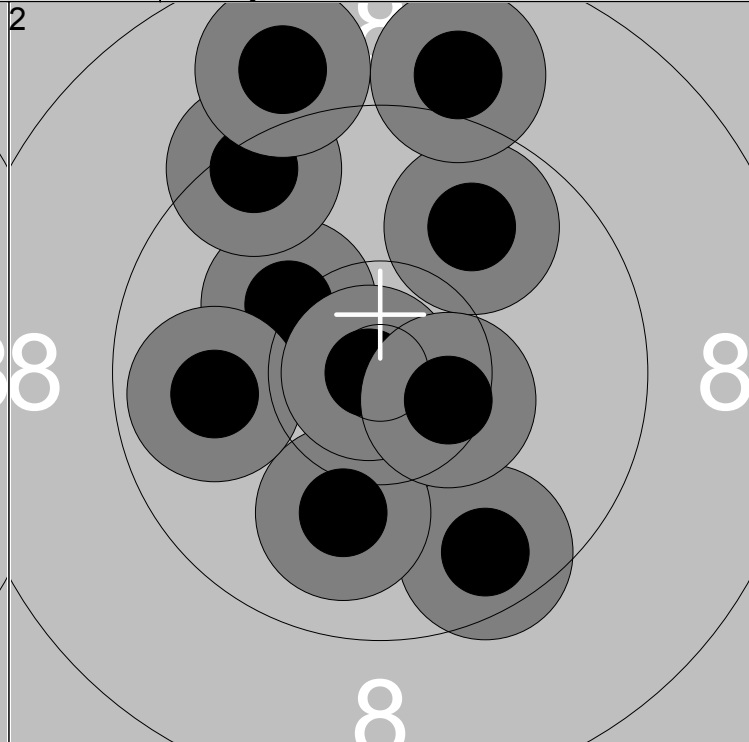
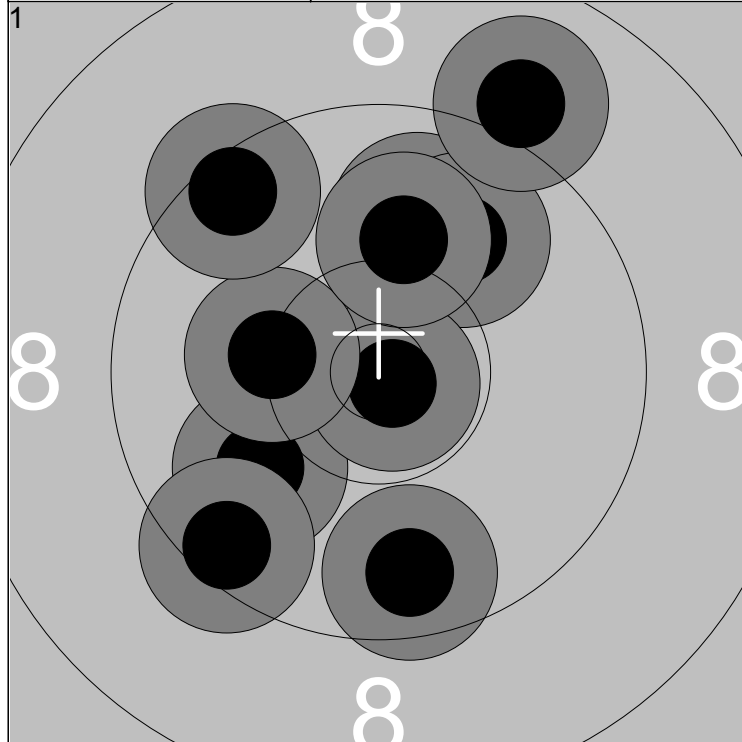

1: 9.7 ↓	6: 10.8x ↘	Series	98.7
2: 10.0 ↙	7: 10.3 ←		
3: 9.9 ↑	8: 10.1 ↑	Series	98.7
4: 9.9 ↗	9: 9.0 ↑		
5: 9.5 ↘	10: 9.5 ↖		

1: 9.8 ↗	6: 10.0 ↓	Series	98.2
2: 10.2 ↖	7: 9.9 ←		
3: 9.4 ↗	8: 8.9 ↑	Series	196.9
4: 9.0 ↑	9: 10.9x ←		
5: 9.6 ↘	10: 10.5x →		

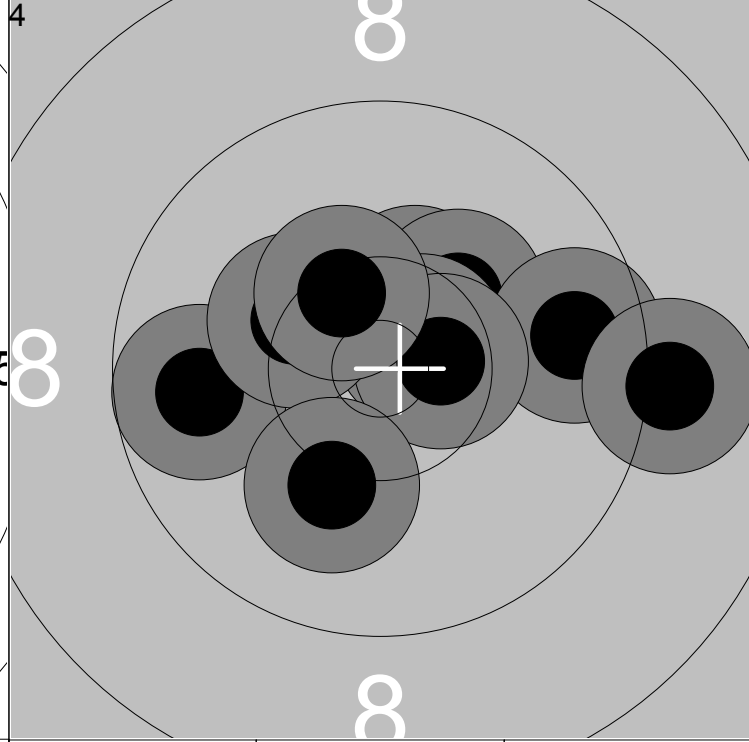
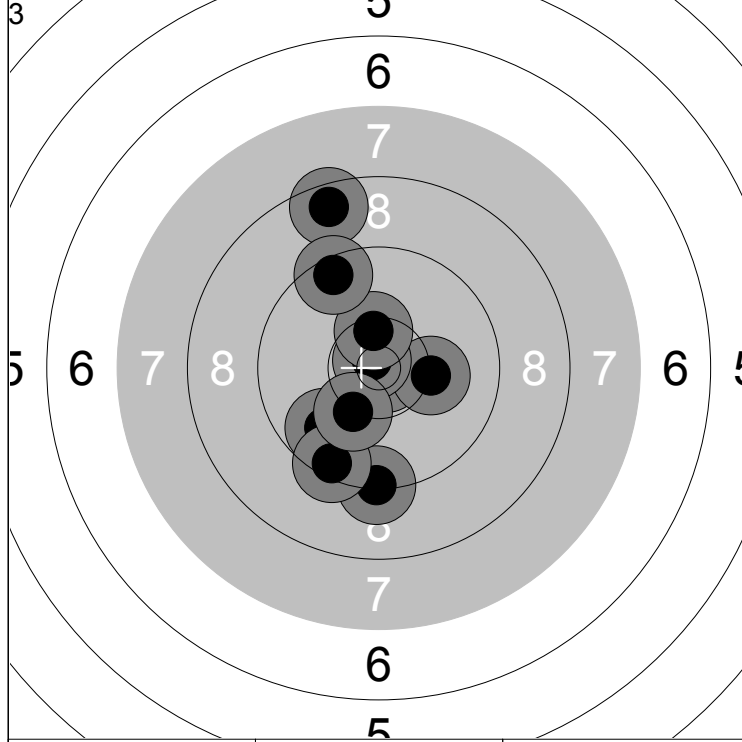

1: 10.8x ↘	6: 10.8x ↖	Series	99.0
2: 9.8 ↙	7: 10.4x ↑		
3: 10.2 →	8: 9.4 ↘	Series	295.9
4: 8.6 ↑	9: 9.5 ↗		
5: 9.3 ↓	10: 10.2 ↘		

1: 10.4x ↗	6: 10.6x →	Series	101.3
2: 9.8 ←	7: 10.3 ↖		
3: 10.3 ↗	8: 10.1 ↘	Series	397.2
4: 9.7 →	9: 10.4x ↖		
5: 10.6x ↗	10: 9.1 →		

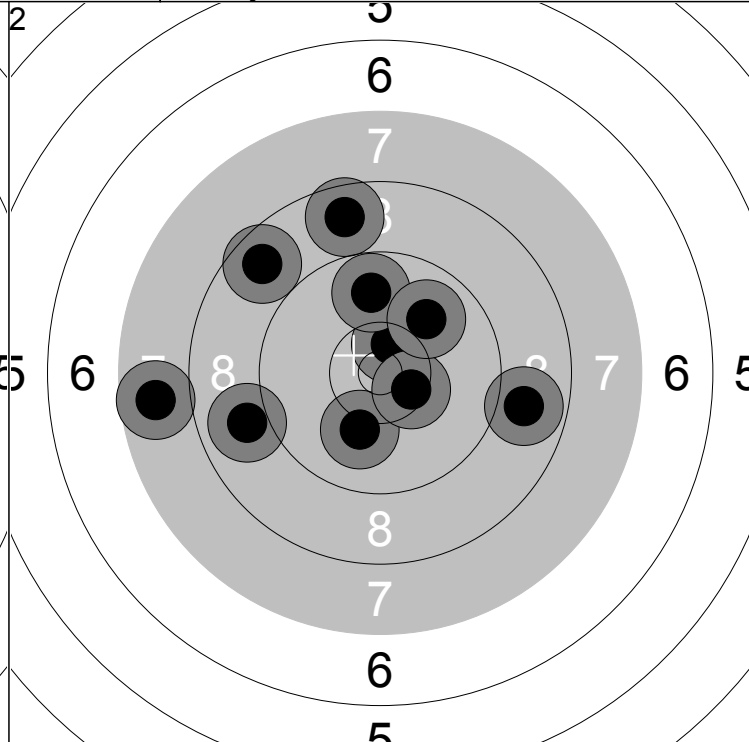
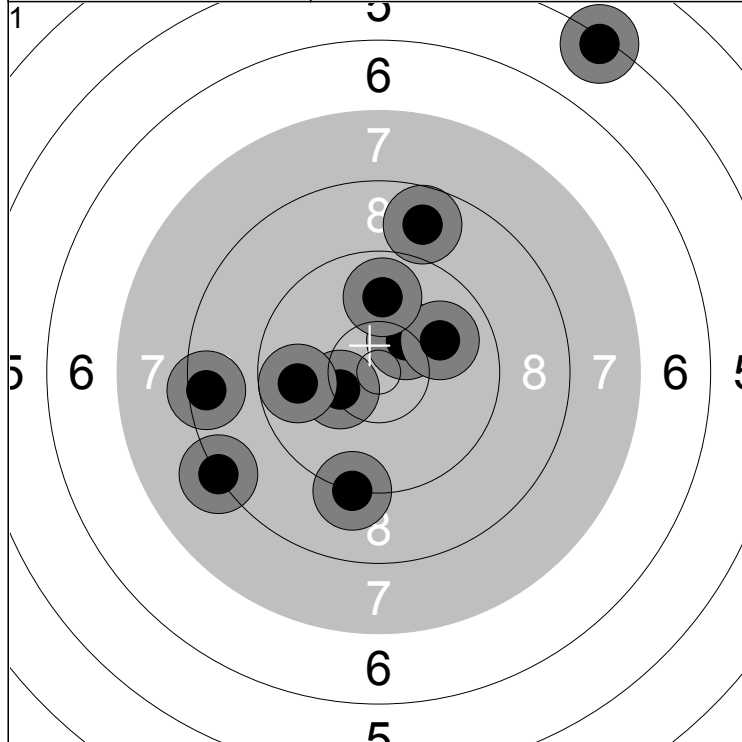

1: 8.8 ↑	6: 9.2 ↓	Series	90.5
2: 10.4x ↗	7: 8.5 ←		
3: 5.3 ↗	8: 10.0 →		
4: 8.3 ↙	9: 9.9 ↑		
5: 10.3 ↙	10: 9.8 ←		
		90.5	

1: 10.5x ↗	6: 8.9 ←	Series	93.7
2: 10.1 ↓	7: 8.9 →		
3: 10.5x ↘	8: 8.7 ↑		
4: 9.8 ↑	9: 9.9 ↗		
5: 7.7 ←	10: 8.7 ↙		
		184.2	

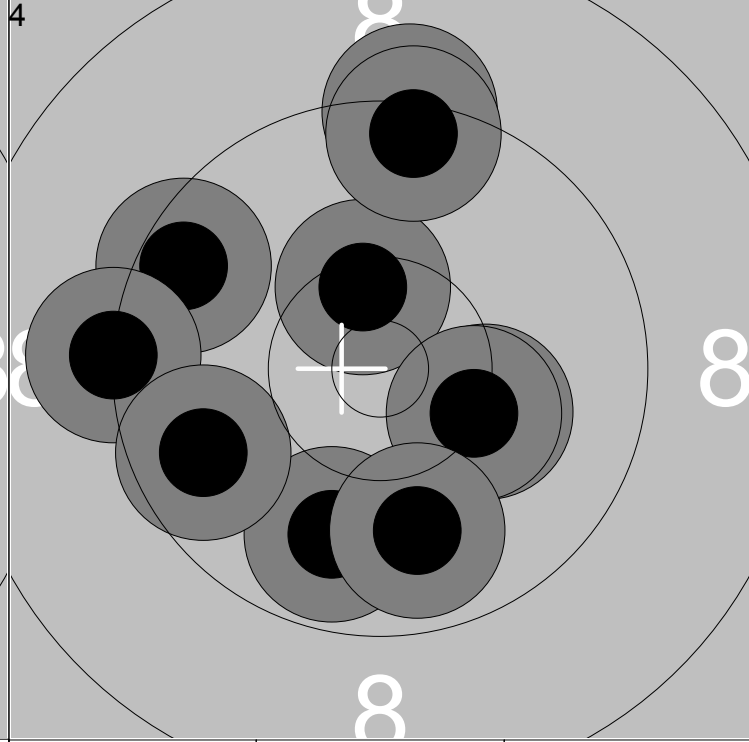
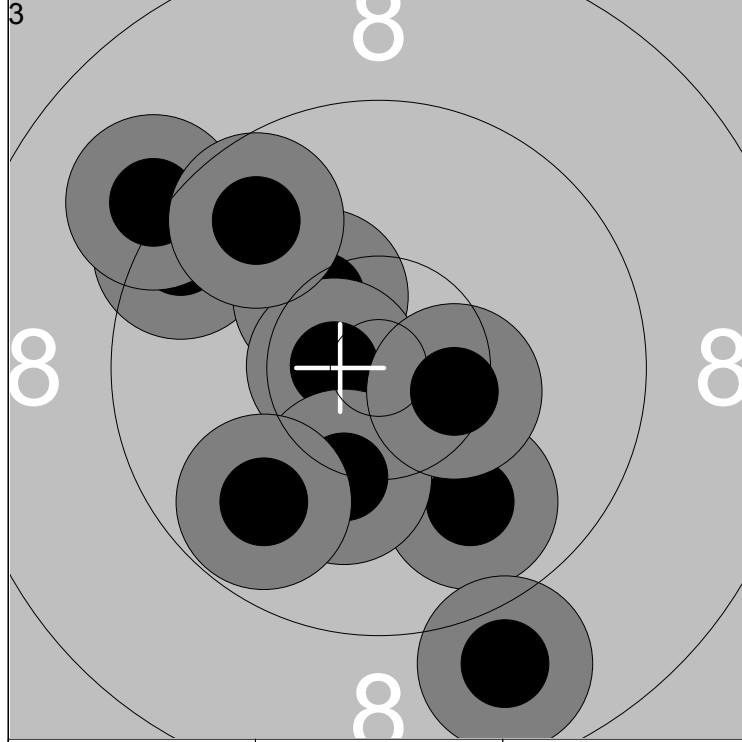

1: 9.9 ↙	6: 10.2 ↓	Series	98.7
2: 9.5 ↗	7: 9.8 ↙		
3: 9.2 ↗	8: 8.9 ↓		
4: 10.4 ↗	9: 9.7 ↗		
5: 10.7x ←	10: 10.4x →		
		282.9	

1: 9.5 ↙	6: 10.3 →	Series	97.7
2: 10.2 →	7: 9.8 ↓		
3: 10.4x ↑	8: 9.9 ↓		
4: 9.3 ↑	9: 9.7 ↙		
5: 9.2 ←	10: 9.4 ↑		
		380.6	

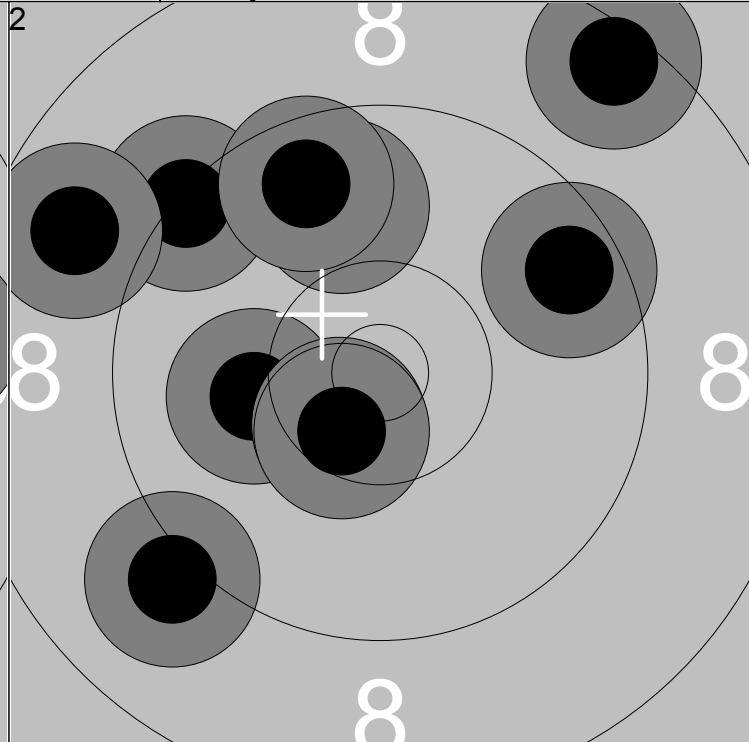
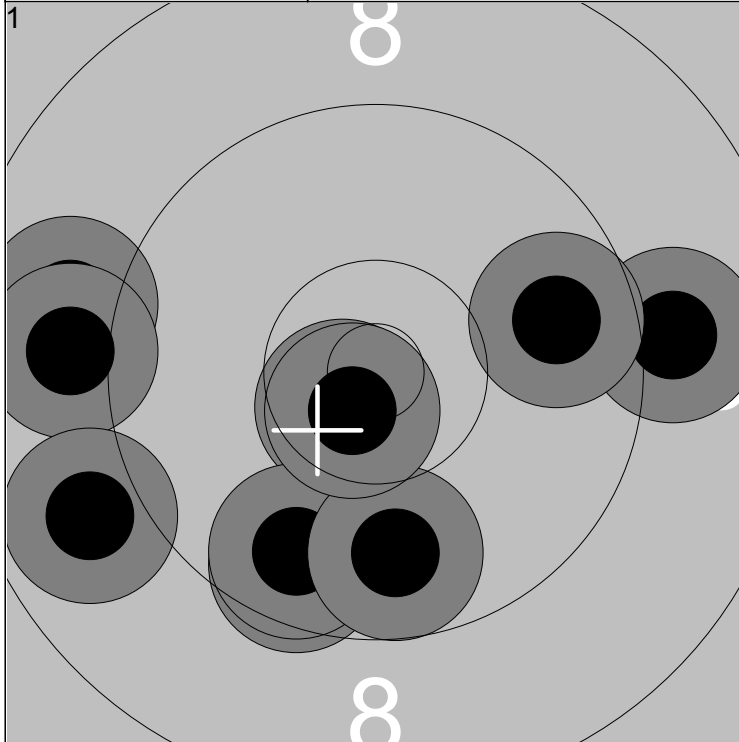

1: 9.0 →	6: 9.7 ↘	Series	95.9
2: 9.6 ↘	7: 9.8 ↘		
3: 8.9 ←	8: 9.7 →	95.9	
4: 10.6x ↘	9: 8.9 ↙		
5: 9.0 ←	10: 10.7x ↘		

1: 9.8 ↑	6: 10.1 ←	Series	95.9
2: 9.3 ↖	7: 10.5x ↘		
3: 8.8 ↖	8: 10.5x ↘	191.8	
4: 8.5 ↗	9: 9.7 ↑		
5: 9.1 ↘	10: 9.6 ↗		

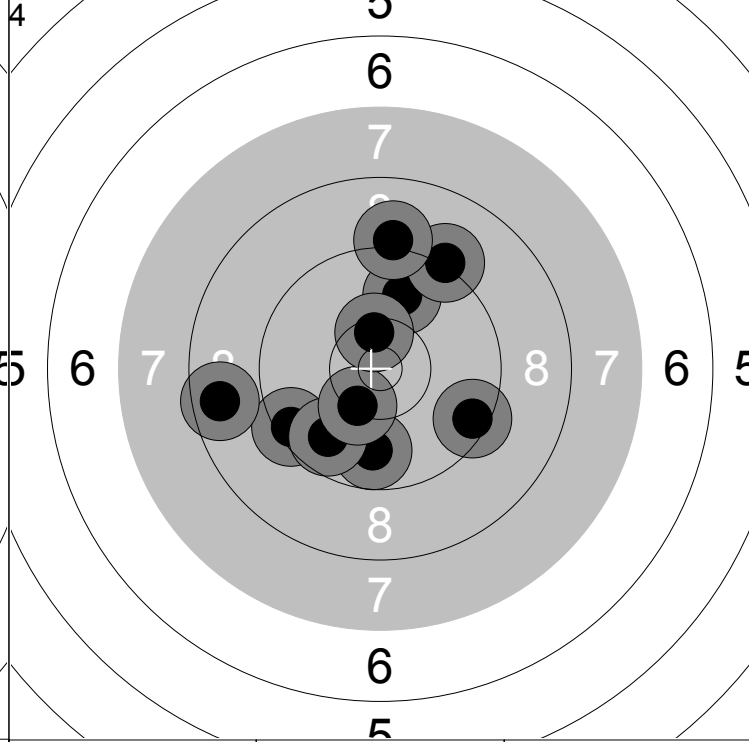
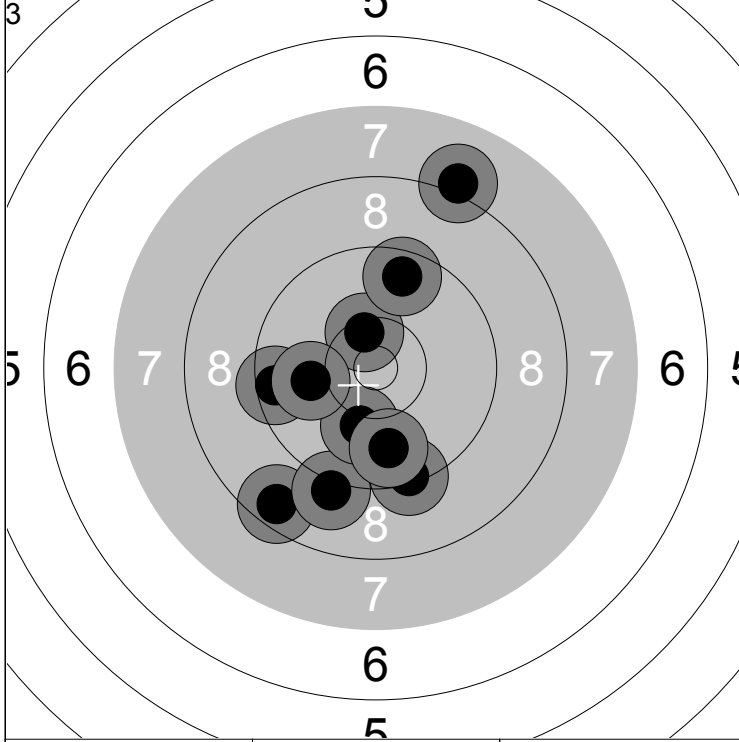

1: 9.5 ←	6: 10.4x ↑	Series	94.5
2: 8.6 ↘	7: 9.6 ↑		
3: 9.1 ↘	8: 10.0 ←	286.3	
4: 10.1 ↘	9: 8.1 ↑		
5: 9.3 ↘	10: 9.8 ↘		

1: 9.9 ↑	6: 9.1 ↑	Series	95.9
2: 9.8 ↘	7: 9.7 ↘		
3: 9.2 ↗	8: 8.6 ←	382.2	
4: 9.5 →	9: 10.3 ↘		
5: 9.4 ↙	10: 10.4x ↑		

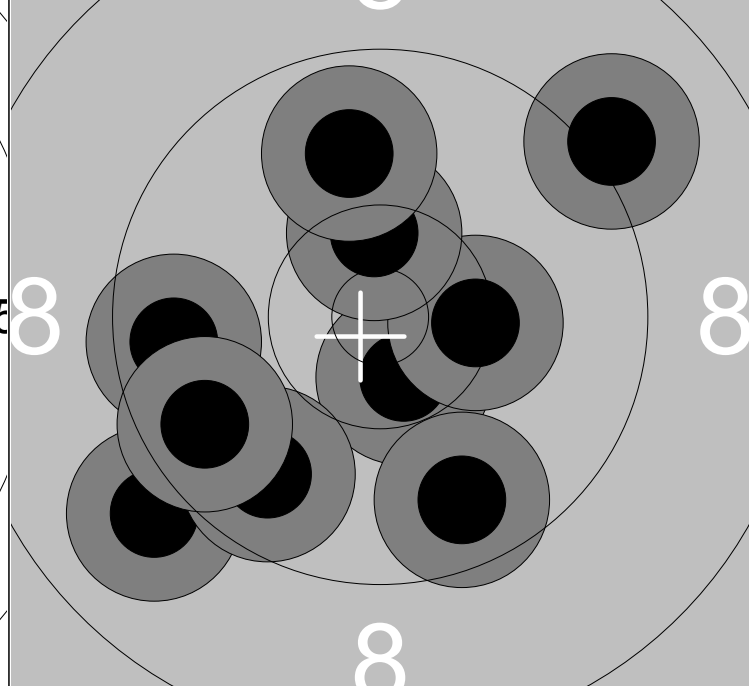
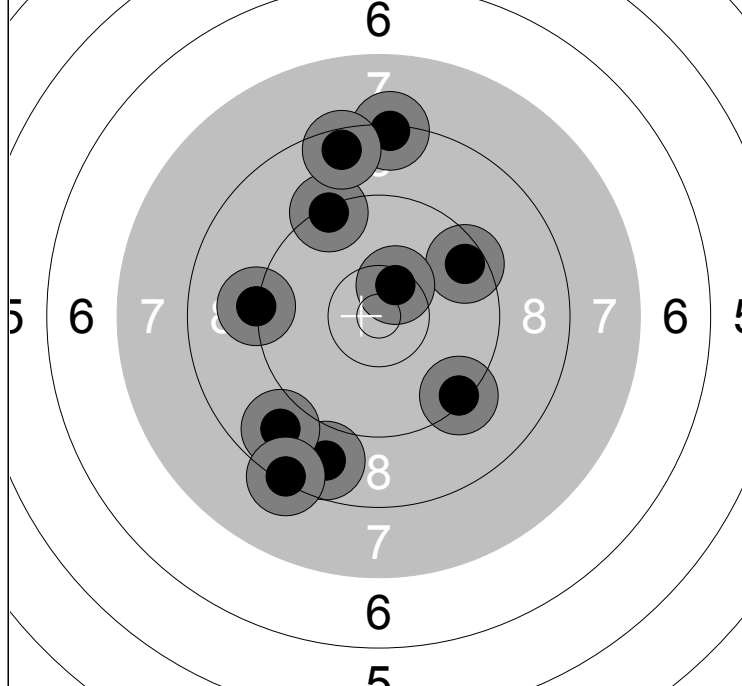

1: 9.5 ↗	6: 8.8 ↘	Series	90.5
2: 8.8 ↘	7: 9.3 ↘		
3: 9.3 ↗	8: 8.5 ↗	90.5	
4: 8.3 ↗	9: 10.5x ↗		
5: 9.2 ←	10: 8.3 ↘		

1: 10.5x ↘	6: 9.1 ↗	Series	97.8
2: 9.6 ←	7: 9.7 ↘		
3: 10.3 →	8: 10.4x ↗	188.3	
4: 9.7 ↘	9: 9.9 ↗		
5: 9.0 ↘	10: 9.6 ↘		

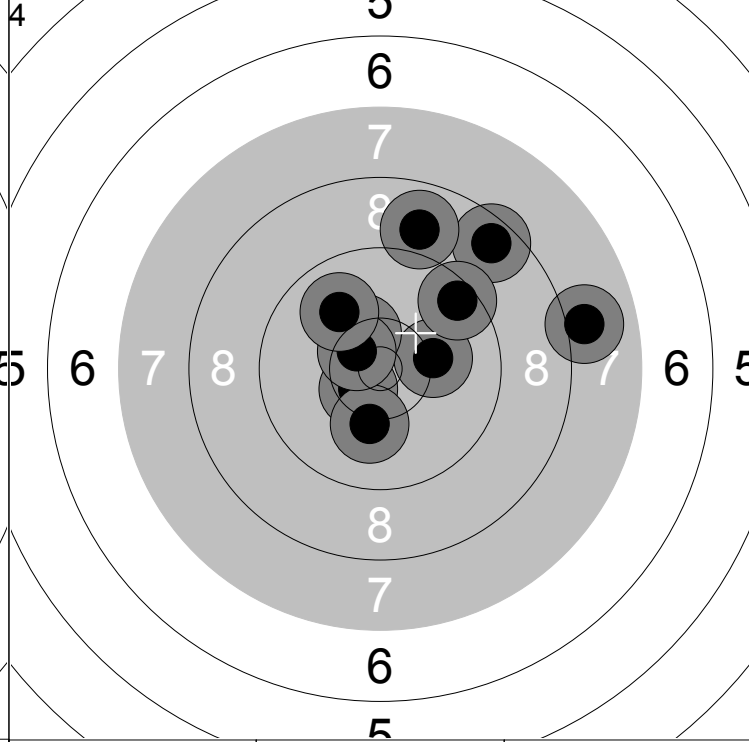
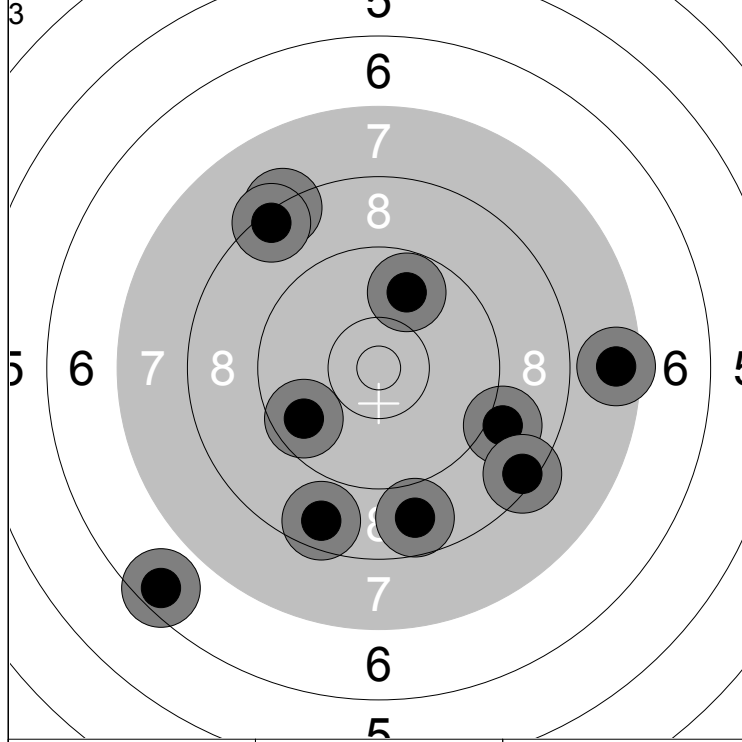

1: 7.6 →	6: 9.0 →	Series	85.1
2: 9.7 ↘	7: 8.4 ↘		
3: 8.6 ↘	8: 6.5 ↘	273.4	
4: 8.3 ↗	9: 9.8 ↗		
5: 8.8 ↘	10: 8.4 ↗		

1: 10.2 →	6: 8.9 ↗	Series	96.8
2: 10.5x ↘	7: 10.2 ↘		
3: 8.6 ↗	8: 8.0 →	370.2	
4: 9.5 ↗	9: 10.5x ↘		
5: 10.4x ↗	10: 10.0 ↘		