

1: 9.9 ↓	6: 10.4x ↓	Series	99.9
2: 10.0 ↘	7: 10.3 ↘		
3: 9.2 ↓	8: 10.5x ←	99.9	
4: 10.7x ↗	9: 10.1 ↗		
5: 9.0 ↗	10: 9.8 ↙		

1: 9.3 ↓	6: 9.9 ↘	Series	100.9
2: 9.4 →	7: 9.5 ↗		
3: 10.5x ↓	8: 10.5x ←	200.8	
4: 10.5x ↓	9: 10.3 ↓		
5: 10.2 ↑	10: 10.8x →		

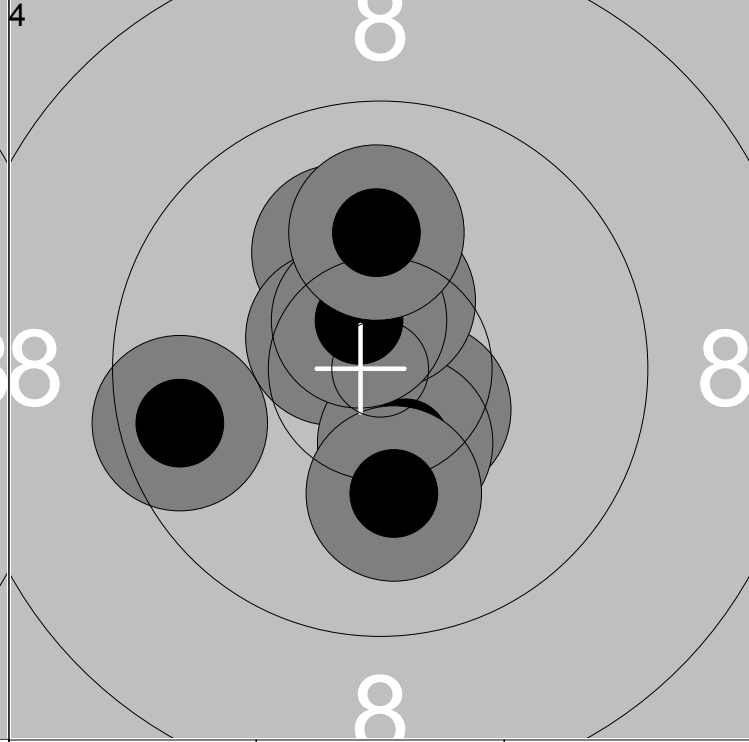
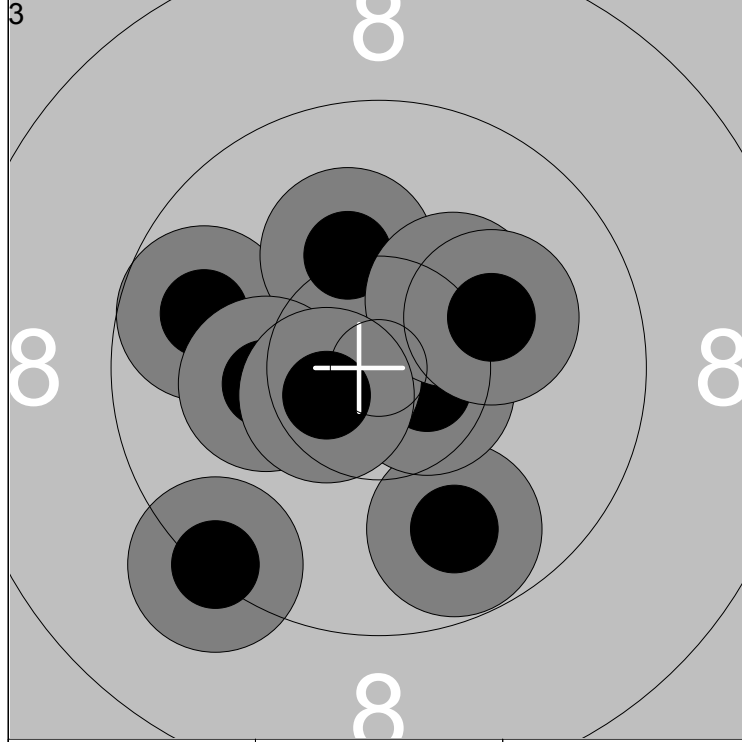

1: 9.8 ↓	6: 10.3 ↗	Series	101.7
2: 10.6x →	7: 9.3 ↘		
3: 10.7x ←	8: 10.2 ↗	302.5	
4: 9.8 ←	9: 10.2 ←		
5: 10.2 ↑	10: 10.6x ↙		

1: 10.6x ↘	6: 10.5x ↓	Series	103.3
2: 9.6 ←	7: 10.5x ↑		
3: 10.5x ↑	8: 10.1 ↓	405.8	
4: 10.2 ↑	9: 10.6x ↗		
5: 10.6x ↙	10: 10.1 ↑		

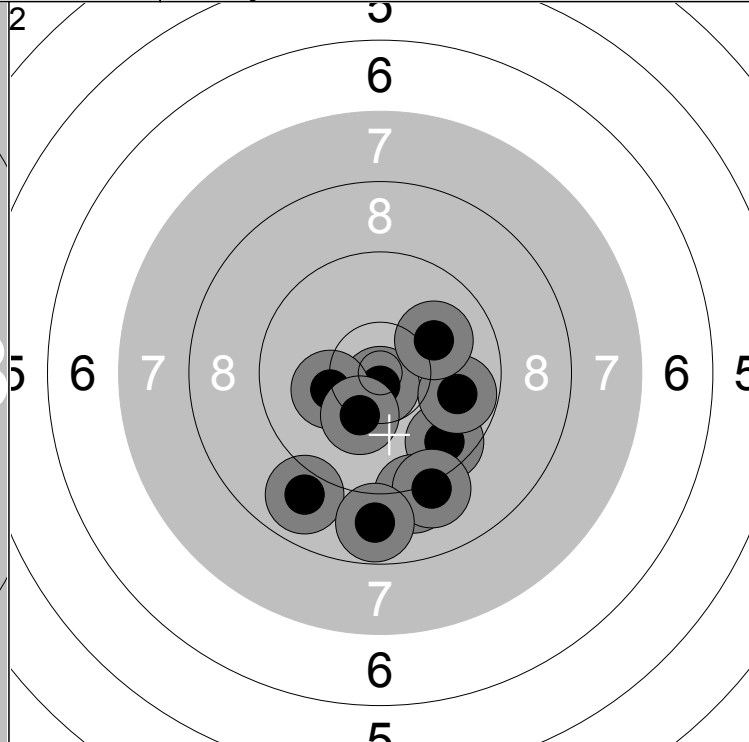
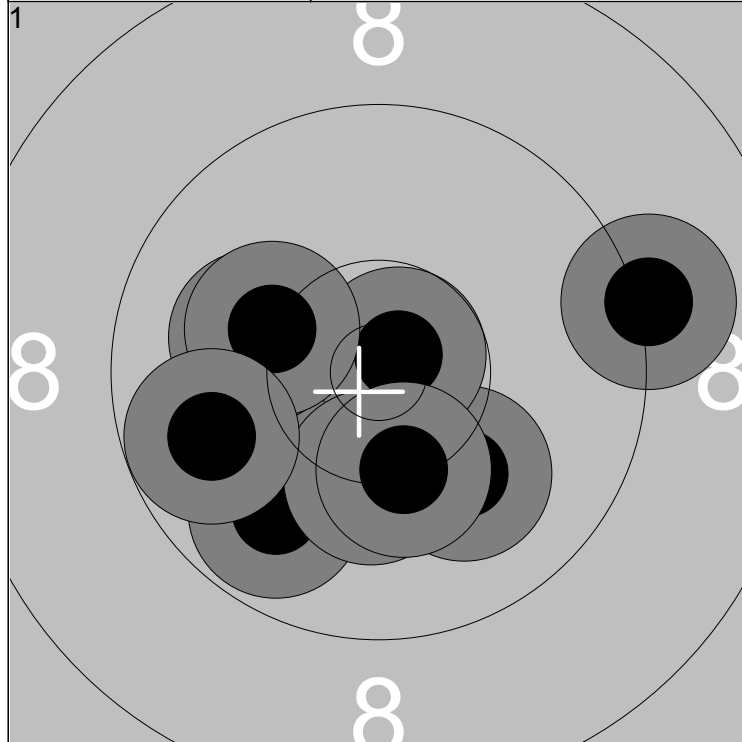

1: 9.8 ↙	6: 10.2 ↖	Series	100.9
2: 10.4x ←	7: 9.1 →		
3: 10.1 ↘	8: 10.3 ↓	100.9	
4: 10.8x ↗	9: 10.3 ↓		
5: 10.1 ←	10: 9.8 ←		

1: 9.6 ↘	6: 10.3 ↙	Series	96.9
2: 9.2 ↓	7: 9.8 →		
3: 10.8x ↓	8: 9.2 ↓	197.8	
4: 10.2 ←	9: 8.8 ↓		
5: 8.9 ↙	10: 10.1 ↗		

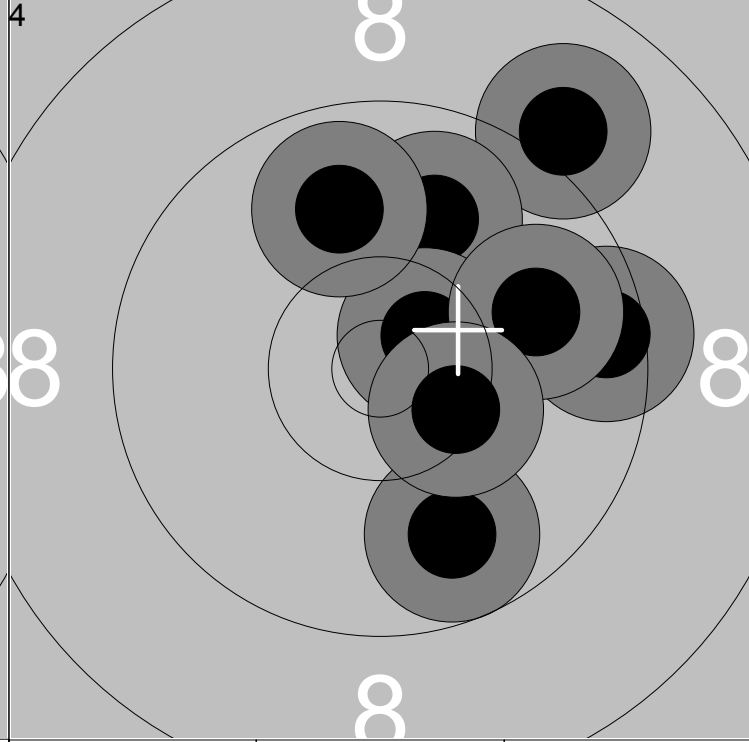
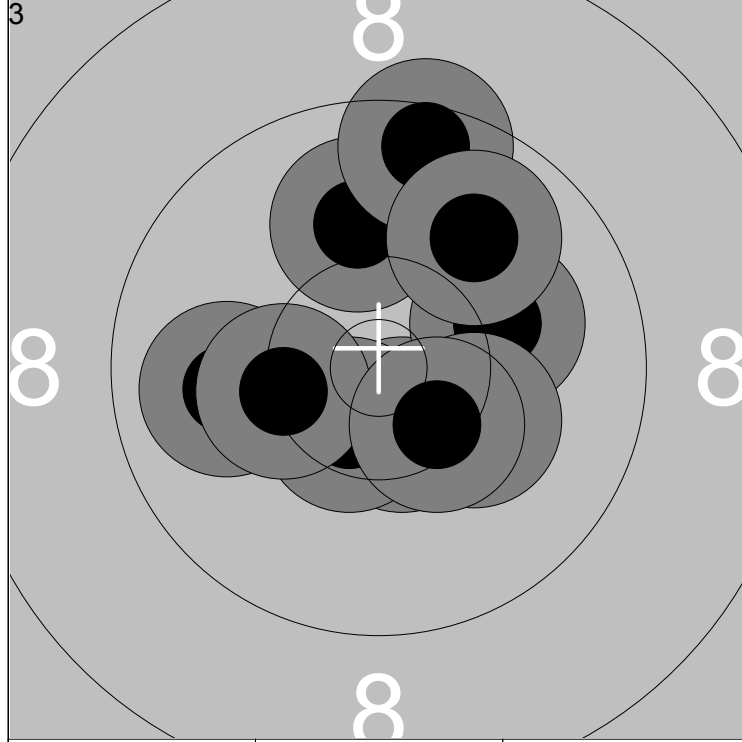

1: 10.0 ←	6: 10.1 →	Series	101.5
2: 10.0 ↑	7: 10.3 ←		
3: 10.6x ↓	8: 10.2 ↘	299.3	
4: 9.5 ↑	9: 9.9 ↗		
5: 10.5x ↙	10: 10.4x ↘		

1: 9.8 ↓	6: 9.9 ↗	Series	99.6
2: 10.3 ↗	7: 10.6x ↗		
3: 9.0 ↗	8: 9.9 →	398.9	
4: 9.5 →	9: 9.9 ↑		
5: 10.3 ↗	10: 10.4x ↘		

Relay	Lane	Bohdan Kyrylenko	
2	19		

Qualification	UKR	Pistol
---------------	-----	--------

2015-10-2/3/4	EYL	Söraby SKF
---------------	-----	------------

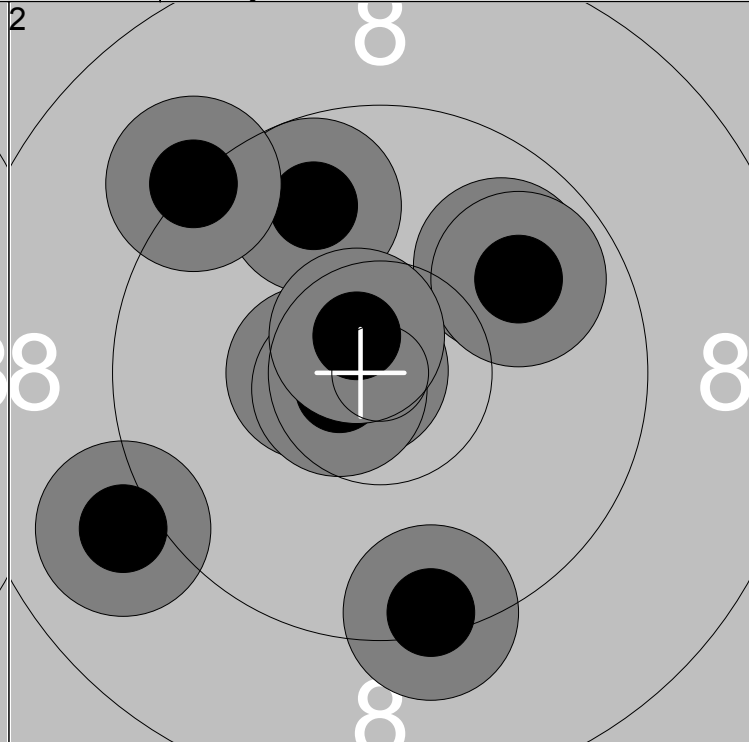
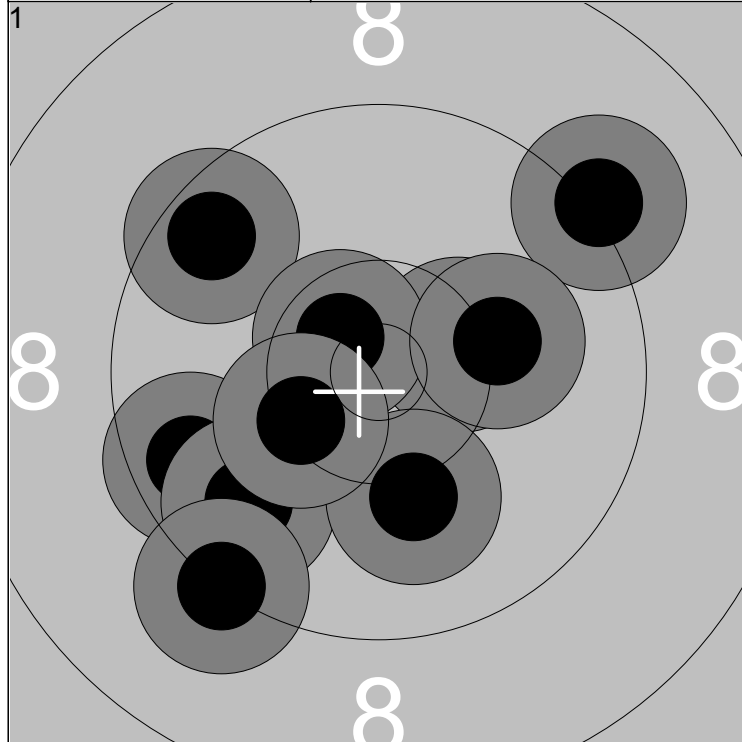

1: 9.6 ↖	6: 9.8 ↙	Series	99.1
2: 10.4x →	7: 9.2 ↙		
3: 9.2 ↗	8: 10.1 ↓		99.1
4: 10.6x ↖	9: 10.4x ↙		
5: 9.6 ↙	10: 10.2 →		

1: 9.8 ↖	6: 10.5x ←	Series	99.9
2: 9.2 ↖	7: 10.8x ←		
3: 9.0 ↙	8: 10.7x ←		199.0
4: 9.9 ↗	9: 10.7x ↖		
5: 9.9 ↗	10: 9.4 ↓		

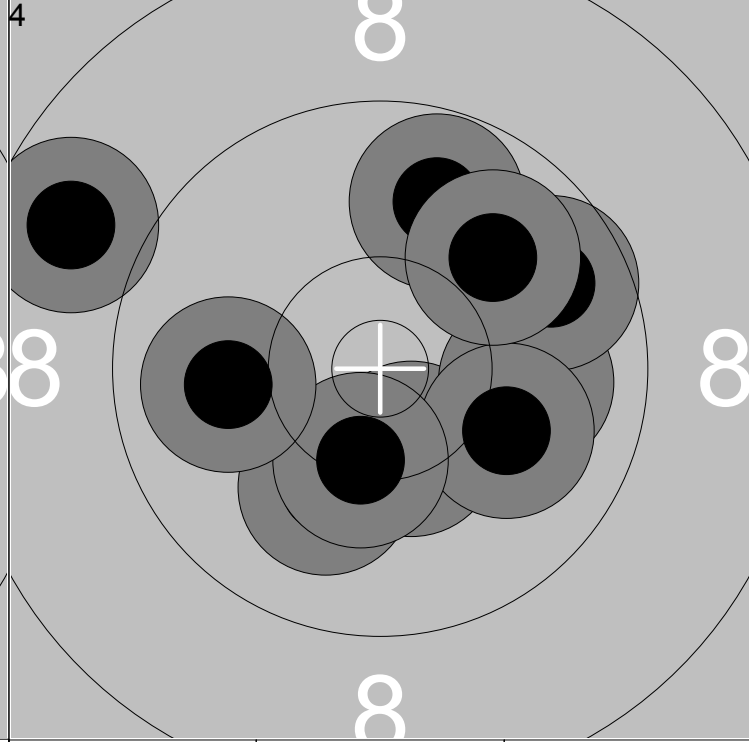
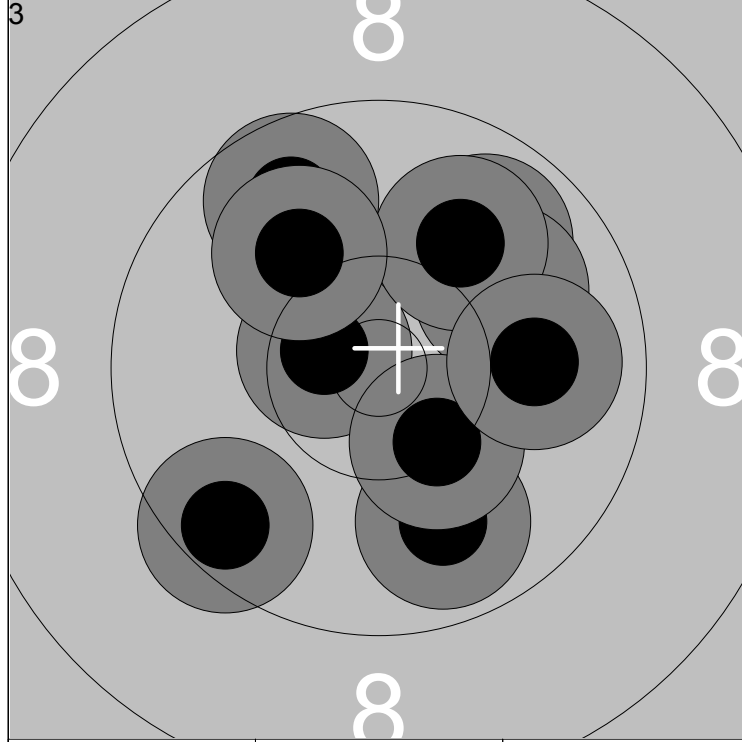

1: 10.6x ←	6: 9.5 ↙	Series	100.0
2: 9.9 ↗	7: 9.7 ↖		
3: 9.9 ↓	8: 10.0 ↗		299.0
4: 10.0 ↗	9: 10.0 →		
5: 10.3 ↓	10: 10.1 ↖		

1: 10.4x ↓	6: 10.3 ↓	Series	99.0
2: 10.1 ↓	7: 10.0 ←		
3: 10.0 →	8: 9.8 ↗		398.0
4: 9.7 ↗	9: 8.8 ←		
5: 10.0 ↘	10: 9.9 ↗		

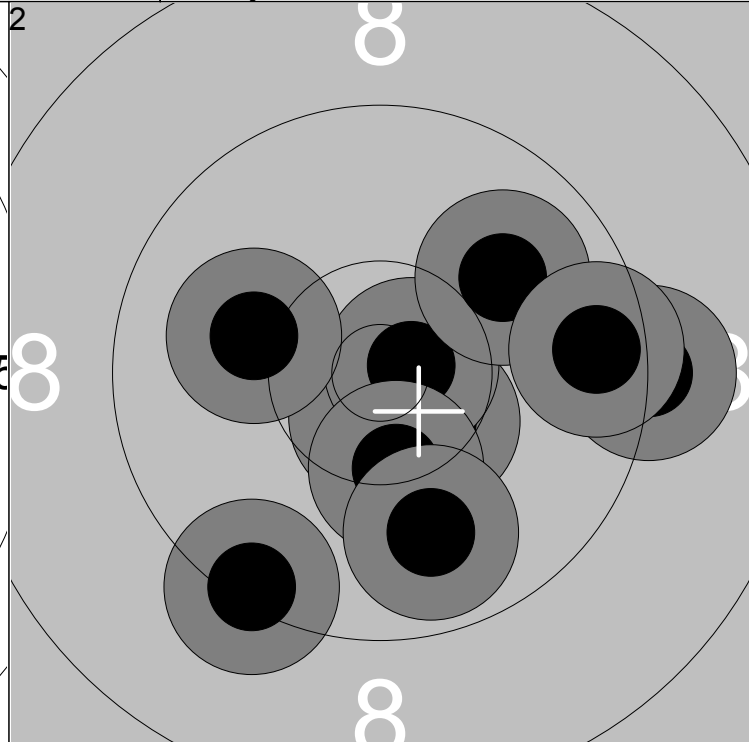
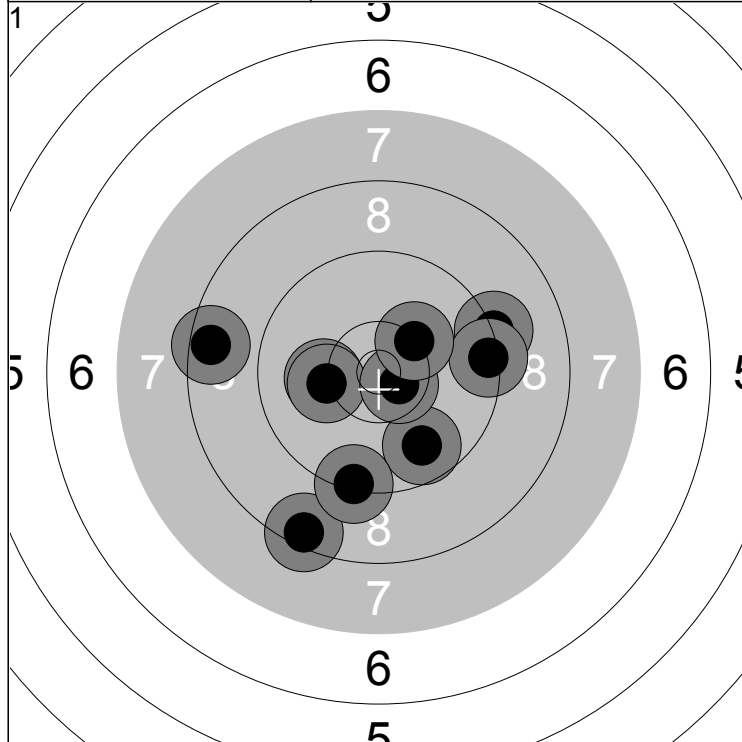

1: 10.2 ←	6: 9.2 →	Series	95.8
2: 8.4 ↓	7: 9.3 ↓		
3: 10.2 ←	8: 10.6x →	95.8	
4: 9.7 ↓	9: 9.4 →		
5: 8.5 ←	10: 10.3 ↗		

1: 10.5x ↘	6: 10.3 ↓	Series	100.2
2: 10.7x ↓	7: 10.1 ←		
3: 9.2 →	8: 10.0 ↗	196.0	
4: 10.7x →	9: 9.9 ↓		
5: 9.3 ↙	10: 9.5 →		

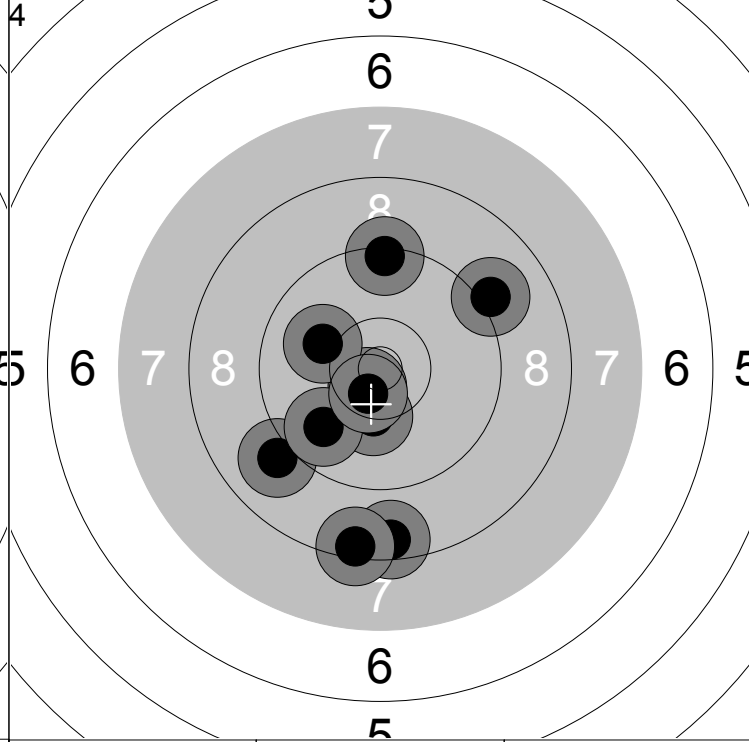
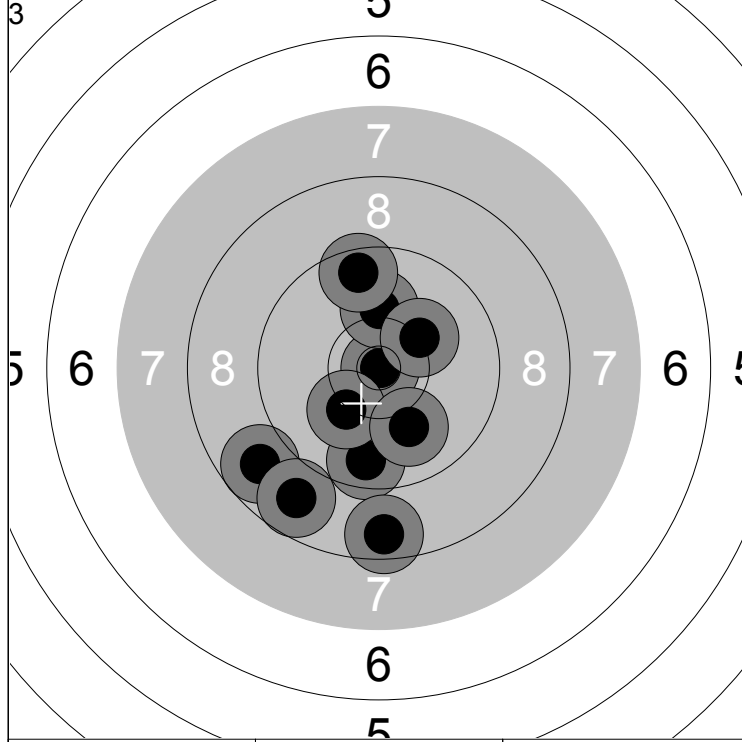

1: 10.9x →	6: 10.2 ↙	Series	96.8
2: 9.6 ↓	7: 10.0 ↓		
3: 10.1 ↑	8: 10.2 ↗	292.8	
4: 8.6 ↓	9: 8.8 ↙		
5: 8.8 ↙	10: 9.6 ↑		

1: 10.3 ↓	6: 8.4 ↓	Series	95.7
2: 8.5 ↓	7: 10.1 ←		
3: 9.0 ↙	8: 9.8 ↙	388.5	
4: 10.6x ↙	9: 9.3 ↑		
5: 9.1 ↗	10: 10.6x ↙		

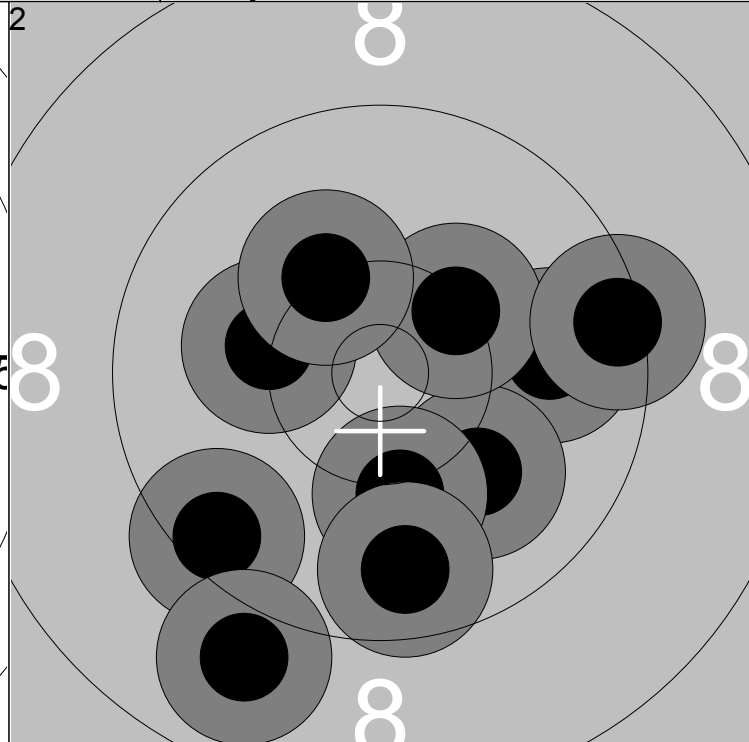
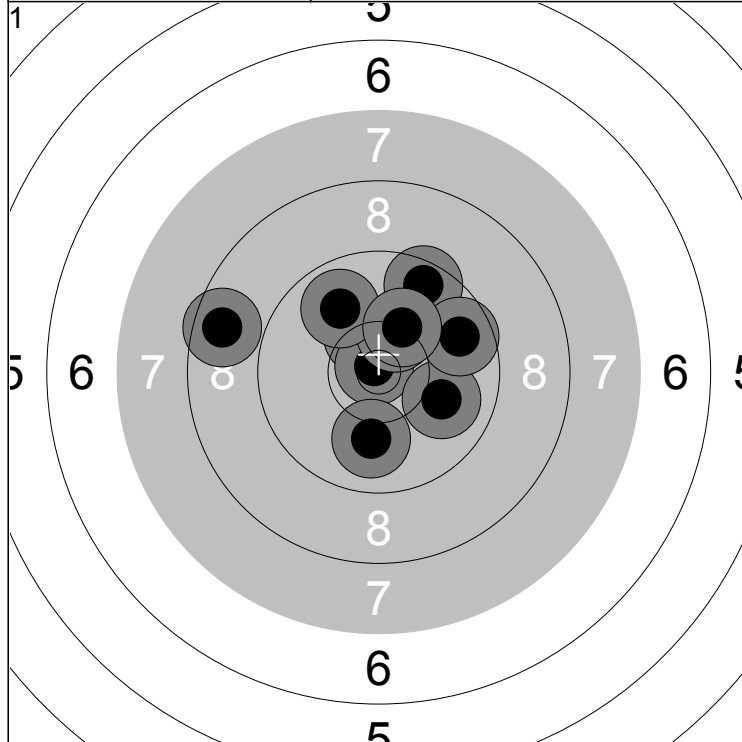

1: 10.4x ↗	6: 8.6 ←	Series	99.5
2: 10.8x ↗	7: 9.6 ↗		
3: 10.0 ↘	8: 9.7 ↗	99.5	
4: 10.3 ↗	9: 10.2 ↗		
5: 9.9 ↗	10: 10.0 ↓		

1: 9.9 →	6: 10.2 ←	Series	98.4
2: 10.1 ↘	7: 10.2 ↗		
3: 9.5 ↙	8: 9.4 →	197.9	
4: 10.3 ↗	9: 8.9 ↘		
5: 10.2 ↓	10: 9.7 ↓		

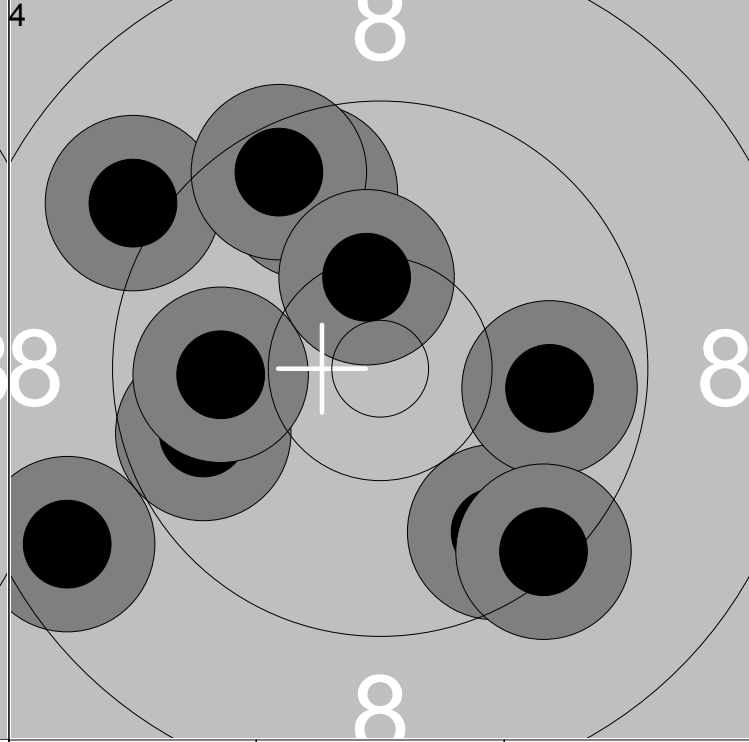
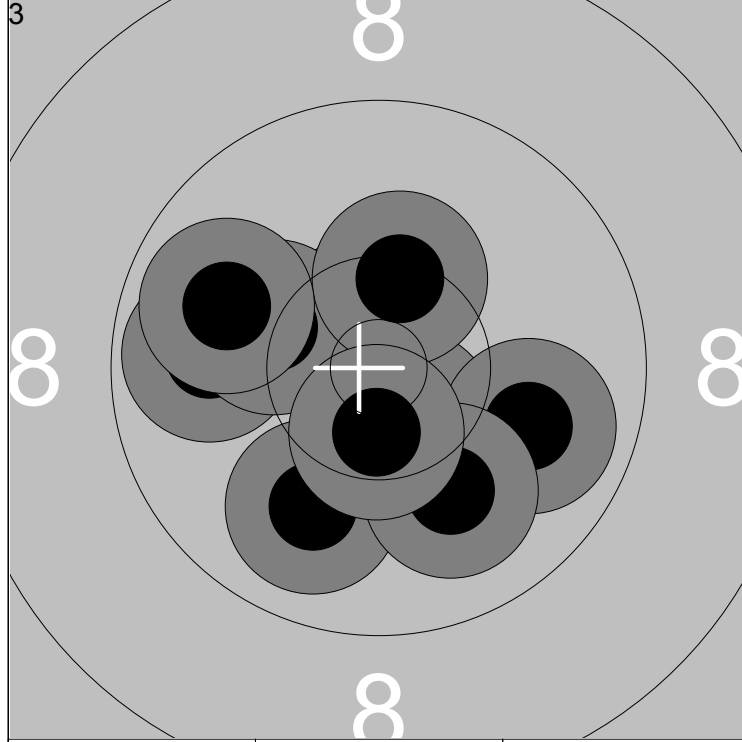

1: 9.9 ←	6: 9.9 →	Series	102.0
2: 10.6x ↗	7: 10.0 ↘		
3: 10.6x ↘	8: 10.4 ↗	299.9	
4: 10.2 ←	9: 9.9 ←		
5: 10.0 ↘	10: 10.5x ↓		

1: 9.7 ←	6: 9.5 ↗	Series	95.8
2: 8.6 ↙	7: 9.9 →		
3: 9.7 ↘	8: 9.9 ←	395.7	
4: 9.0 ↗	9: 10.4x ↗		
5: 9.7 ↗	10: 9.4 ↘		

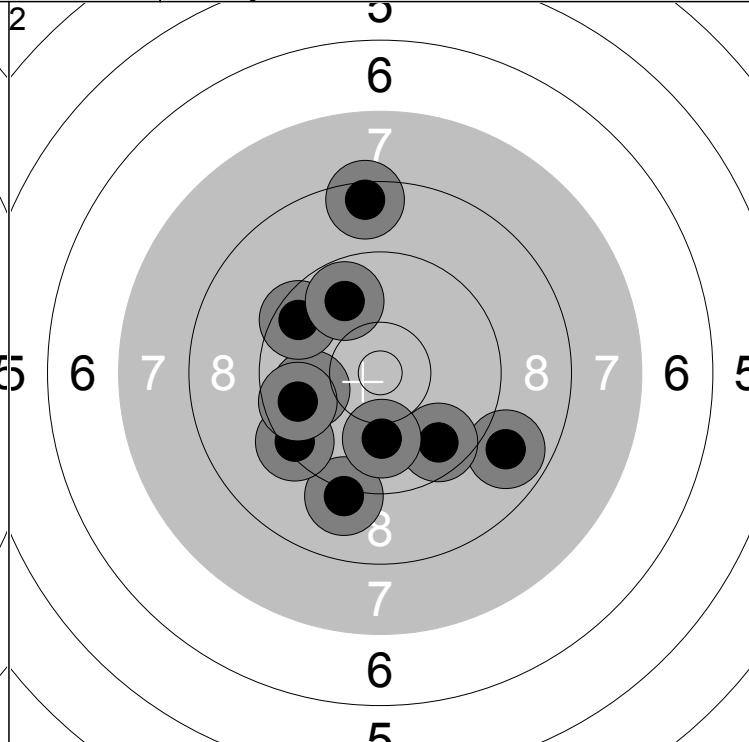
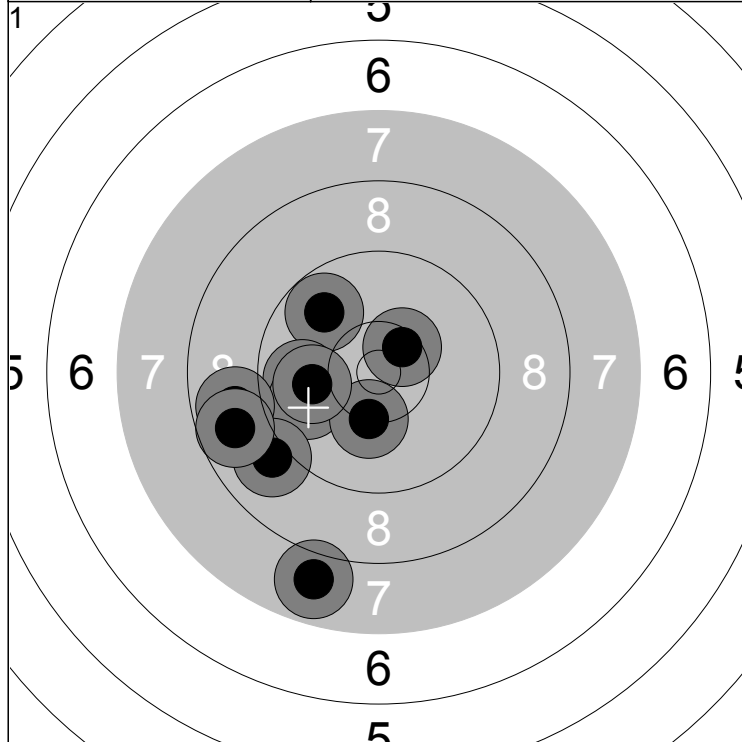

1: 9.8 ↗	6: 10.5x ↗	Series	95.0
2: 9.9 ←	7: 7.9 ↓		
3: 9.9 ←	8: 8.9 ←		
4: 9.0 ↙	9: 8.8 ←		
5: 10.3 ↓	10: 10.0 ←		
		95.0	

1: 9.1 ↓	6: 10.0 ↓	Series	94.6
2: 8.9 ↘	7: 9.7 ←		
3: 9.4 ↙	8: 8.5 ↑		
4: 9.9 ←	9: 9.6 ↖		
5: 9.7 ↘	10: 9.8 ↗		
		189.6	

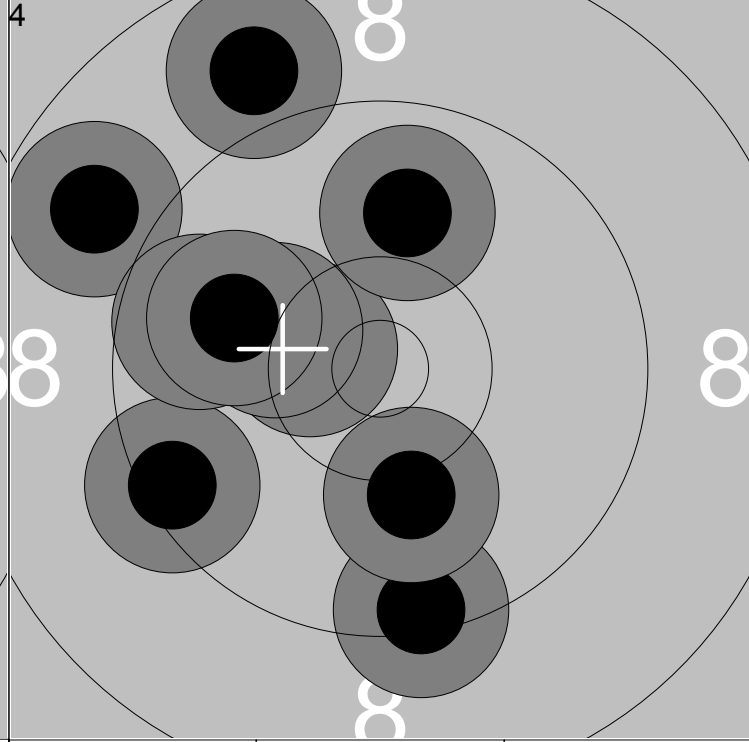
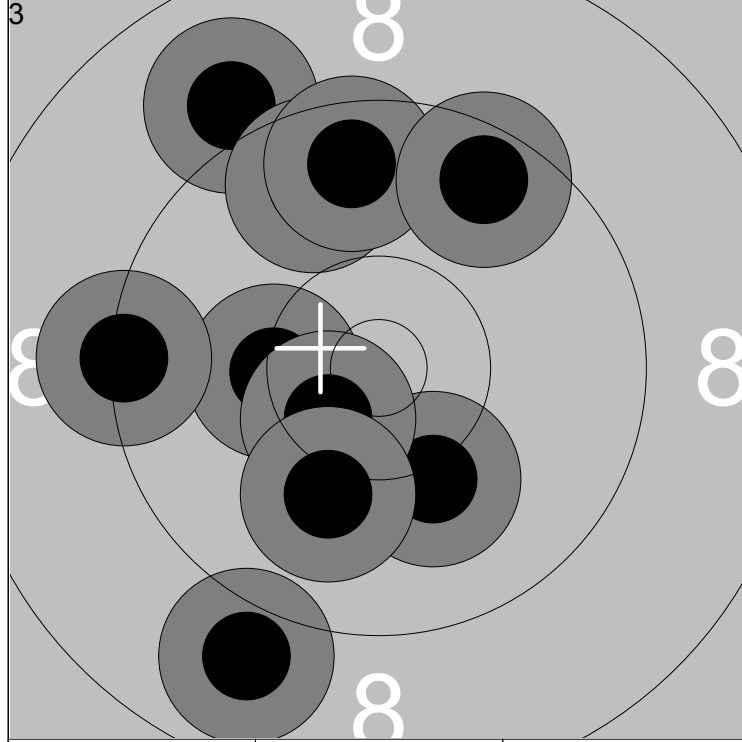

1: 9.0 ↗	6: 9.6 ↗	Series	97.2
2: 9.7 ↗	7: 8.9 ↓		
3: 9.6 ↑	8: 10.2 ↓		
4: 10.3 ←	9: 10.5x ↙		
5: 9.3 ←	10: 10.1 ↓		
		286.8	

1: 9.4 ↙	6: 9.7 ←	Series	97.0
2: 10.5x ←	7: 10.0 ←		
3: 8.9 ↗	8: 9.4 ↓		
4: 8.9 ↖	9: 10.1 ↓		
5: 10.2 ↖	10: 9.9 ↑		
		383.8	

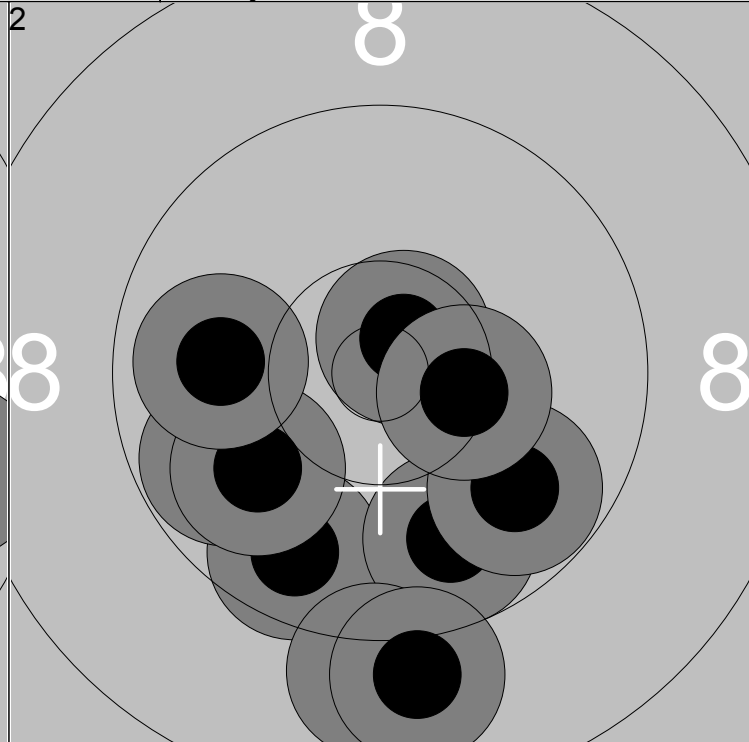
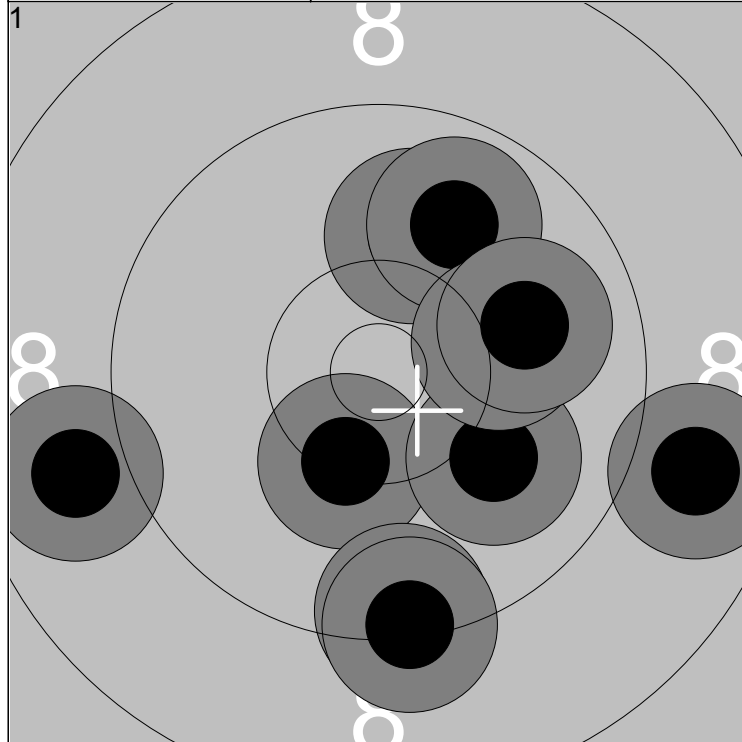

1: 8.8 →	6: 10.0 ↘	Series	96.9
2: 10.1 ↑	7: 10.2 →		
3: 10.3 ↘	8: 8.9 ←	96.9	
4: 9.9 ↗	9: 10.0 →		
5: 9.4 ↓	10: 9.3 ↓		

1: 9.7 ↙	6: 9.9 ←	Series	98.0
2: 9.8 ↙	7: 10.7x ↗		
3: 9.8 ↘	8: 9.0 ↓	194.9	
4: 9.0 ↓	9: 9.8 ↘		
5: 9.9 ↙	10: 10.4x →		

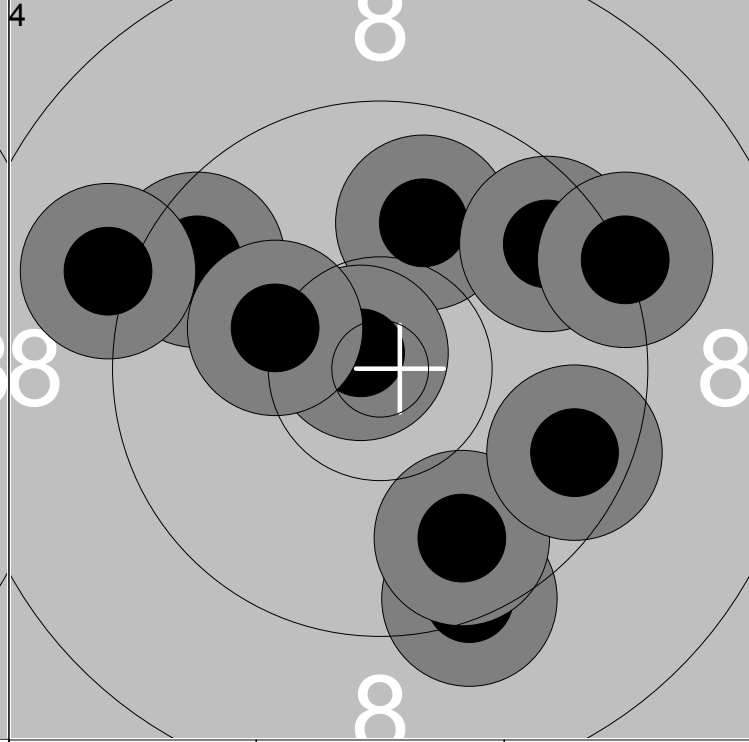
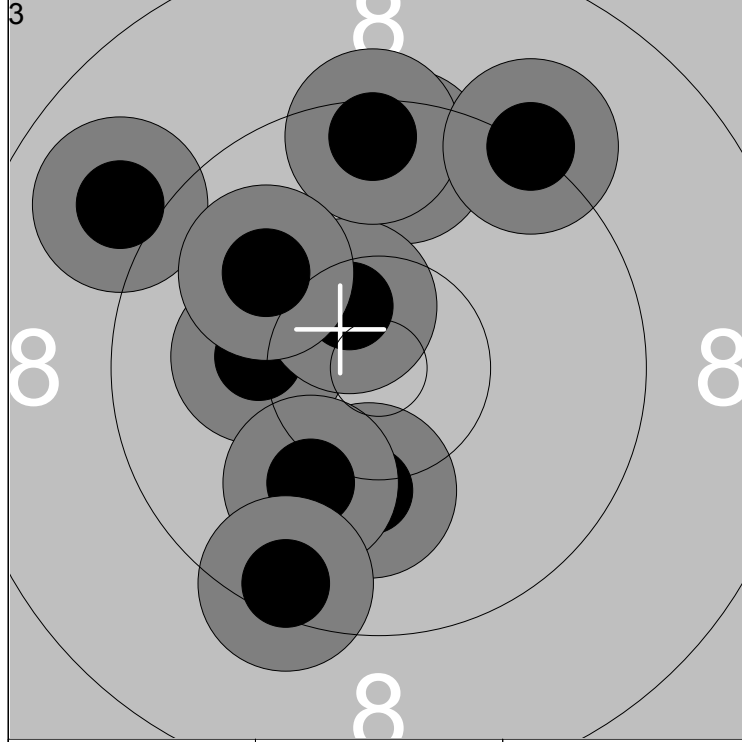

1: 9.6 ↑	6: 10.5x ↗	Series	97.7
2: 10.2 ←	7: 9.5 ↑		
3: 10.2 ↓	8: 9.4 ↘	292.6	
4: 9.0 ↙	9: 10.0 ↖		
5: 10.1 ↘	10: 9.2 ↗		

1: 9.6 ↖	6: 10.2 ←	Series	97.2
2: 9.4 ↓	7: 9.6 ↗		
3: 9.7 ↘	8: 9.2 →	389.8	
4: 10.0 ↑	9: 9.1 ←		
5: 10.8x ↖	10: 9.6 ↘		

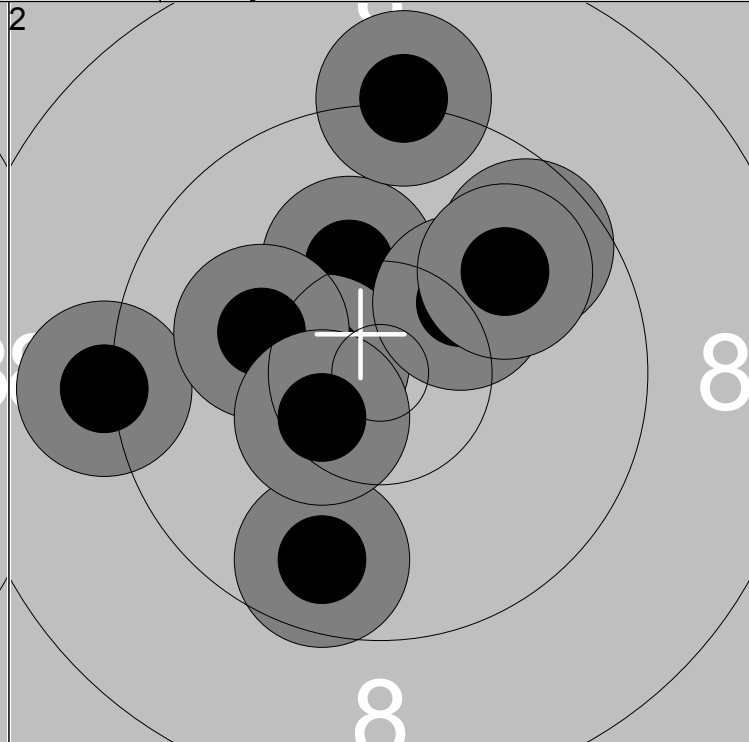
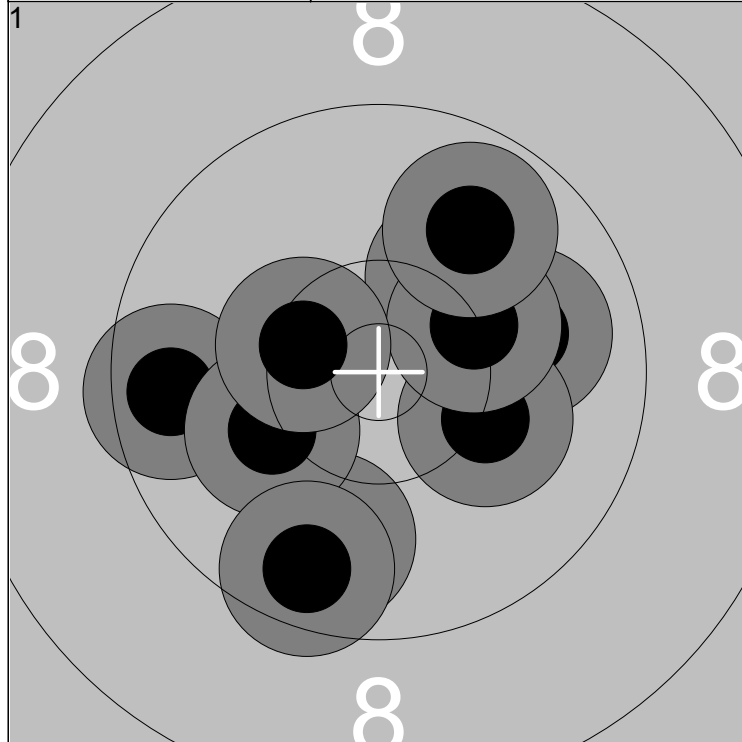

1: 9.6 ←	6: 10.2 ↙	Series	100.2
2: 10.0 →	7: 9.6 ↓		
3: 10.2 ↗	8: 10.3 ↘	100.2	
4: 9.8 ↓	9: 9.9 ↗		
5: 10.2 ↘	10: 10.4x ←		

1: 9.2 ←	6: 9.7 ↗	Series	99.4
2: 9.7 ↓	7: 9.2 ↑		
3: 10.2 ↗	8: 10.3 ↗	199.6	
4: 10.6x ←	9: 10.5x ↙		
5: 10.1 ←	10: 9.9 ↗		

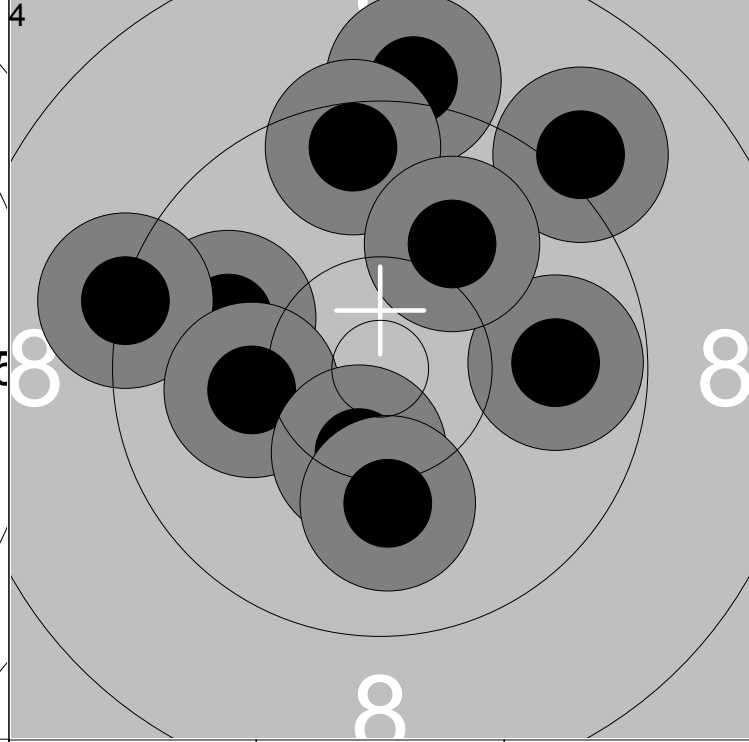
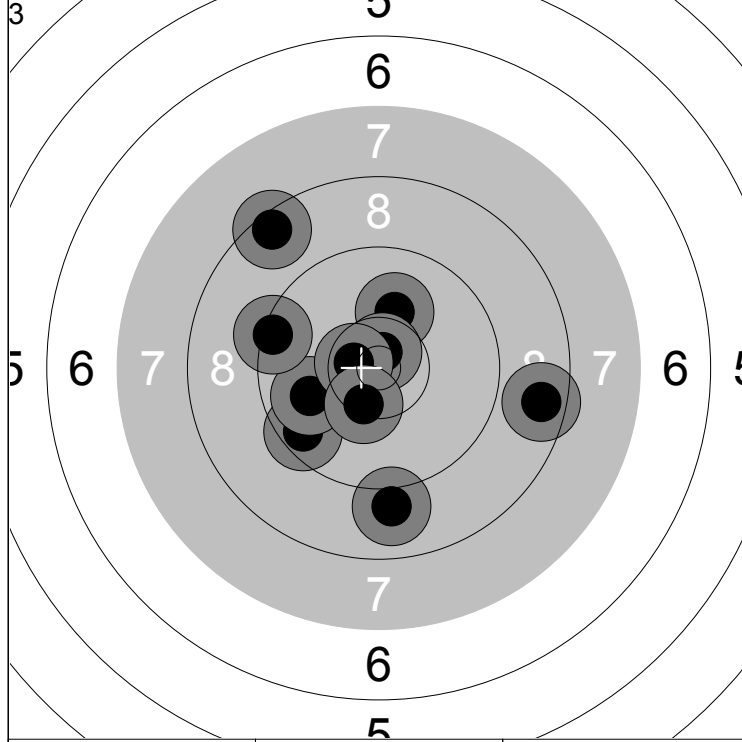

1: 10.1 ↑	6: 9.4 ↙	Series	96.8
2: 8.6 →	7: 9.0 ↓		
3: 9.6 ↙	8: 10.6x ←	296.4	
4: 10.7x ↑	9: 10.4x ↓		
5: 9.9 ←	10: 8.5 ↗		

1: 9.9 ↙	6: 9.5 ↑	Series	97.3
2: 9.1 ↑	7: 10.0 ↗		
3: 9.3 ↙	8: 10.1 ←	393.7	
4: 9.8 →	9: 10.4x ↓		
5: 9.1 ↗	10: 10.1 ↓		

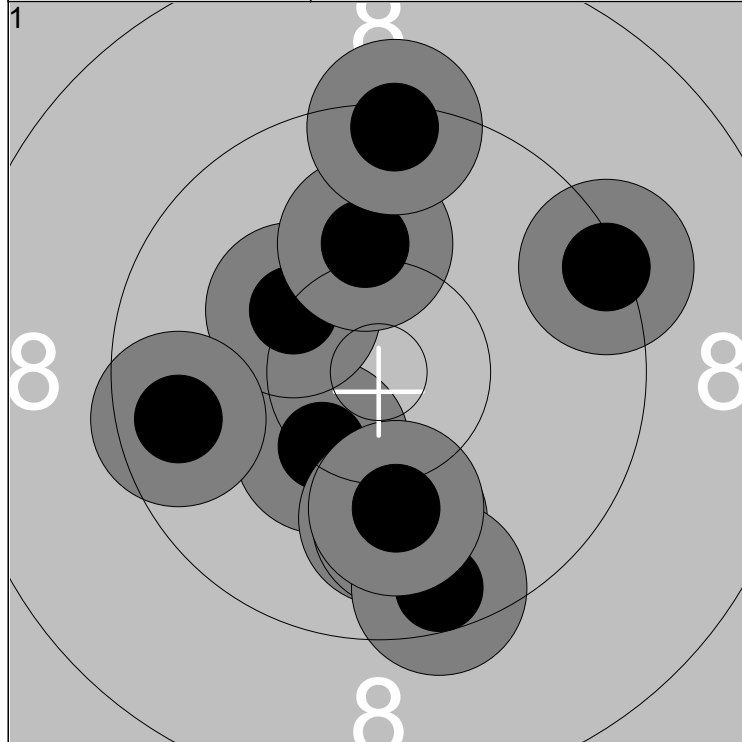

1: 10.4x ↙	6: 10.0 ↓	Series	
2: 10.3 ↖	7: 9.5 ↓		98.7
3: 10.0 ↓	8: 9.4 ↑	Series	
4: 10.1 ↑	9: 9.3 ↗		98.7
5: 9.6 ←	10: 10.1 ↓		

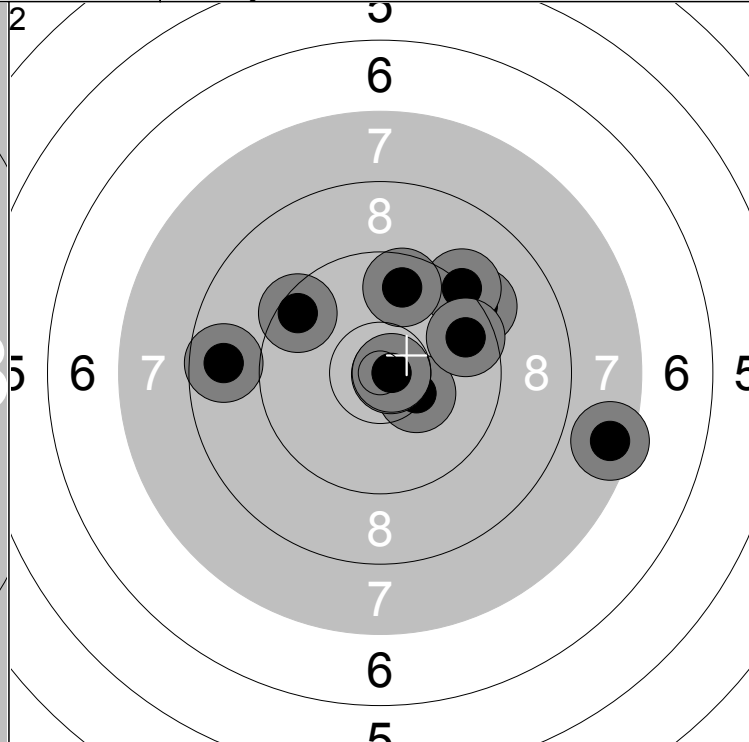

1: 8.7 ←	6: 10.8x →	Series	
2: 9.3 ↗	7: 9.6 →		95.7
3: 9.3 ↗	8: 10.8x →	Series	
4: 10.4x ↘	9: 9.7 ↑		194.4
5: 9.5 ↖	10: 7.6 →		

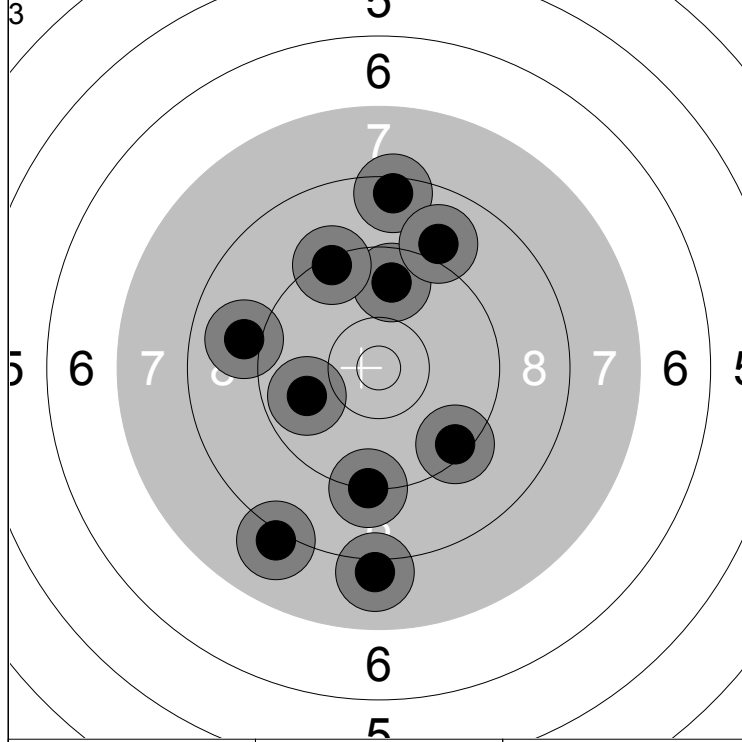

1: 9.0 ←	6: 8.5 ↑	Series	
2: 9.4 ↘	7: 9.2 ↓		90.2
3: 9.7 ↑	8: 8.1 ↘	Series	
4: 9.3 ↗	9: 9.9 ←		284.6
5: 8.1 ↓	10: 9.0 ↗		

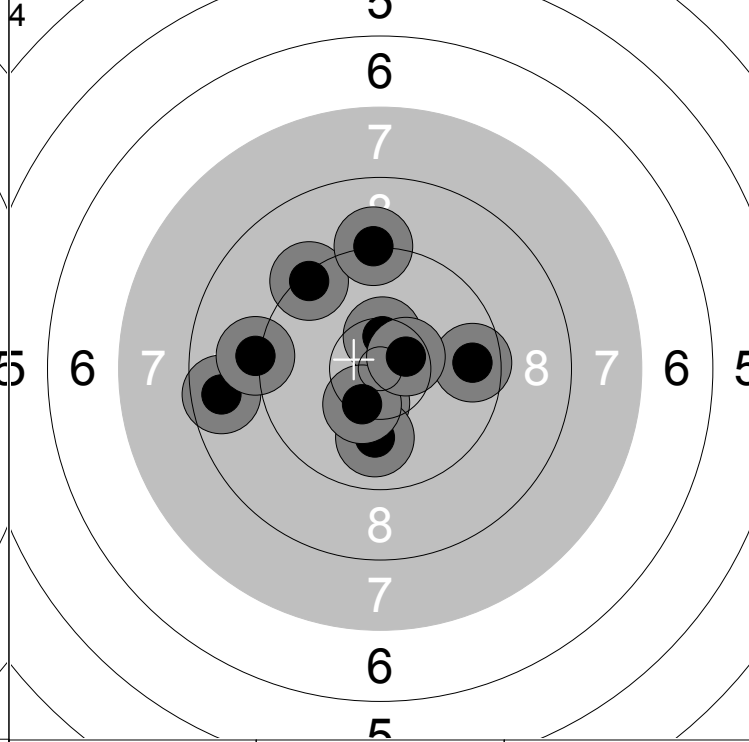

1: 10.4x ↓	6: 10.4x ↓	Series	
2: 9.3 ↖	7: 9.6 →		97.9
3: 10.5x ↑	8: 9.2 ←	Series	
4: 10.0 ↓	9: 10.6x ↗		382.5
5: 8.7 ←	10: 9.2 ↑		

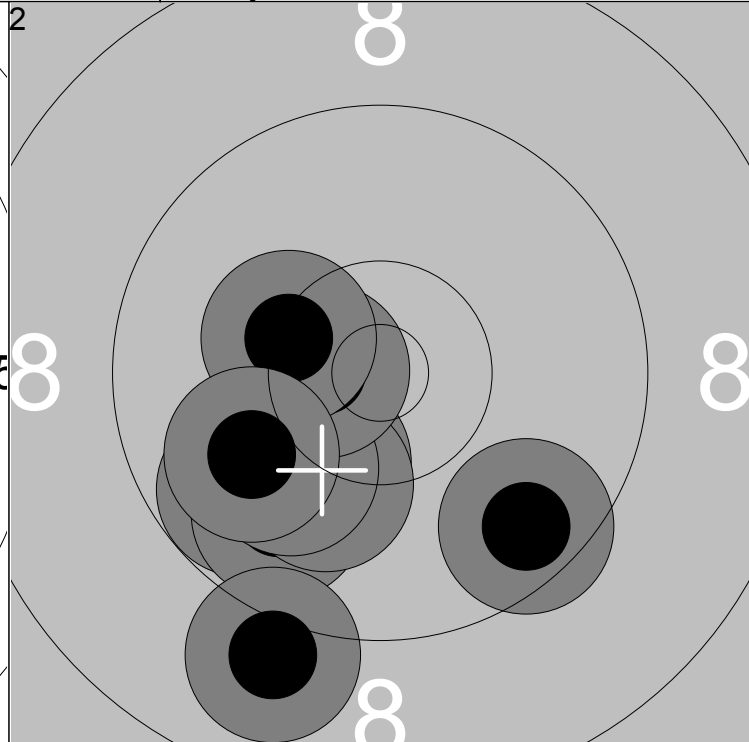
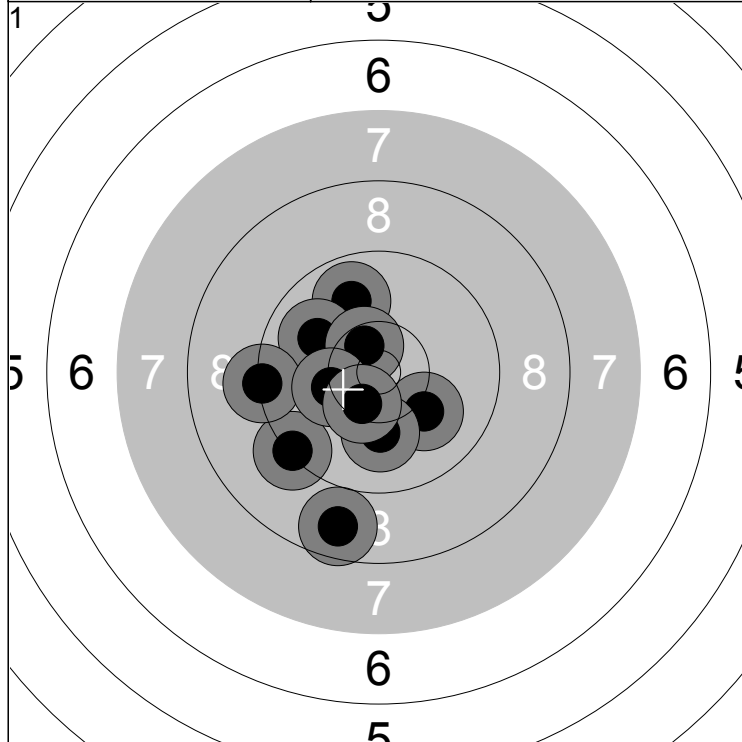

1: 10.1	2: 9.9	3: 10.1	4: 9.3	5: 8.7	6: 9.9	7: 9.3	8: 10.5x	9: 10.2	10: 10.4x		
					Series					98.4	
										98.4	

1: 9.8	2: 9.8	3: 10.3	4: 10.2	5: 10.1	6: 9.6	7: 10.6x	8: 10.3	9: 9.0	10: 10.0		
					Series					99.7	
										198.1	

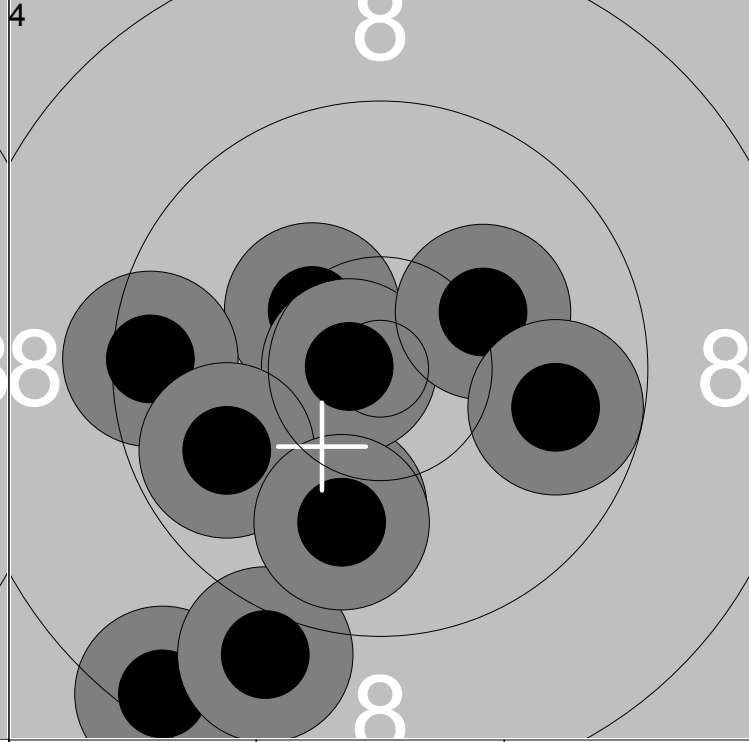
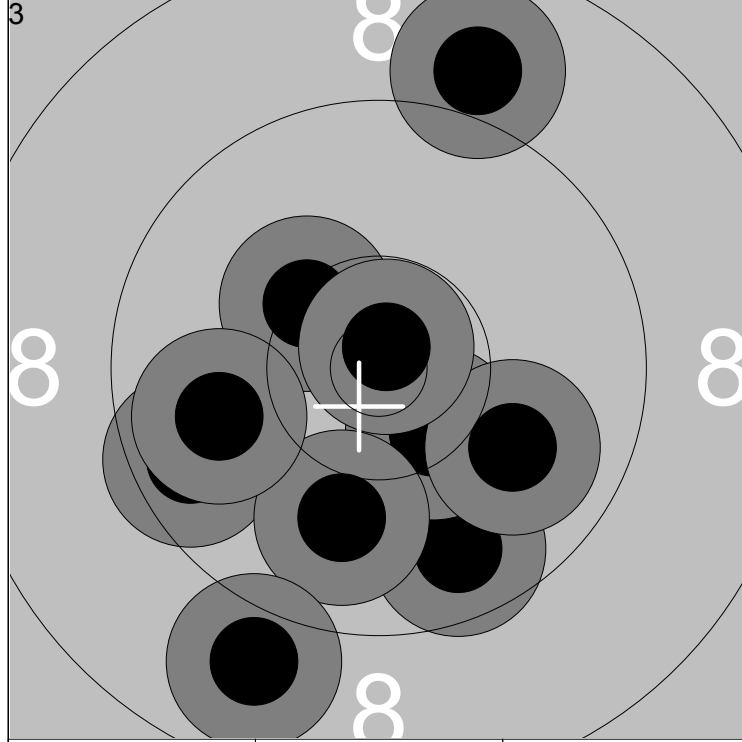

1: 9.6	2: 8.9	3: 9.7	4: 10.4x	5: 10.0	6: 9.9	7: 8.9	8: 10.3	9: 9.9	10: 10.8x		
					Series					98.4	
										296.5	

1: 10.0	2: 8.4	3: 10.4x	4: 10.8x	5: 9.5	6: 10.2	7: 9.0	8: 9.8	9: 9.8	10: 9.9		
					Series					97.8	
										394.3	

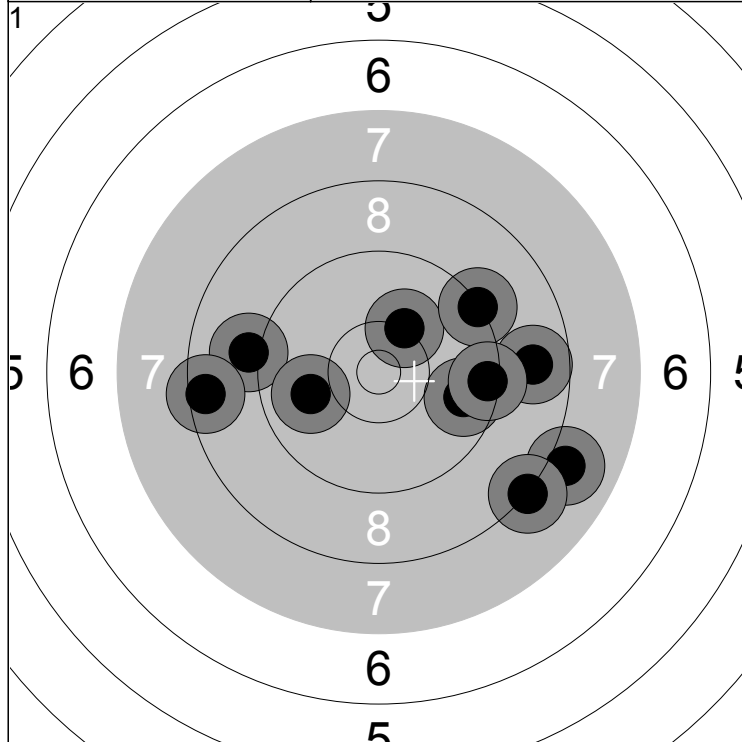

1: 9.1 ←	6: 8.8 →	Series	91.1
2: 10.2 ↗	7: 8.2 ↘		
3: 8.5 ←	8: 9.3 ↗		91.1
4: 9.7 →	9: 9.9 ←		
5: 8.0 ↘	10: 9.4 →		

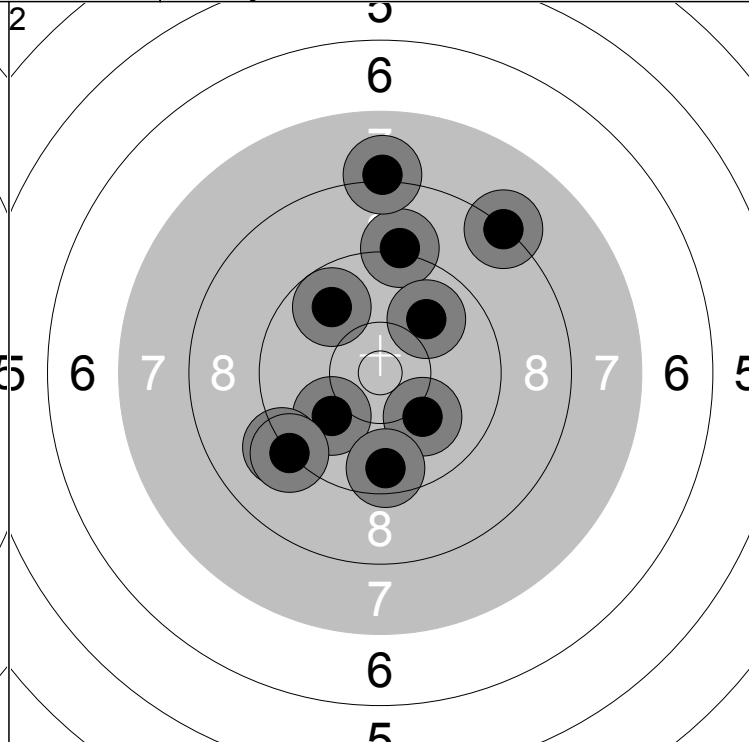

1: 9.1 ↑	6: 9.9 ↗	Series	93.3
2: 10.0 ↘	7: 10.1 ↘		
3: 9.2 ↘	8: 8.3 ↗		184.4
4: 8.1 ↑	9: 9.8 ↖		
5: 9.2 ↘	10: 9.6 ↓		

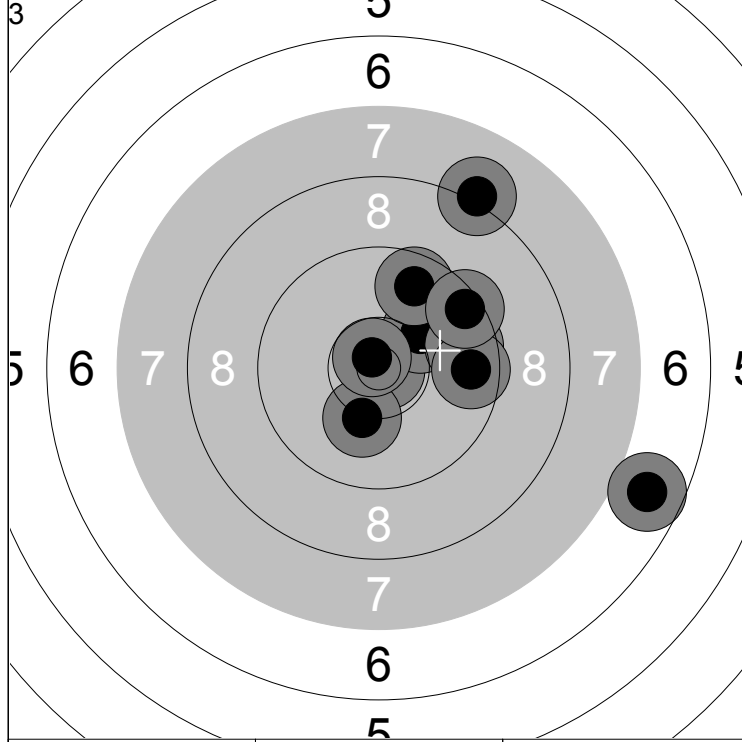

1: 10.8x →	6: 9.7 →	Series	95.3
2: 6.7 →	7: 9.6 →		
3: 10.2 ↓	8: 9.7 ↗		279.7
4: 8.1 ↗	9: 9.5 ↗		
5: 10.2 ↗	10: 10.8x ↖		

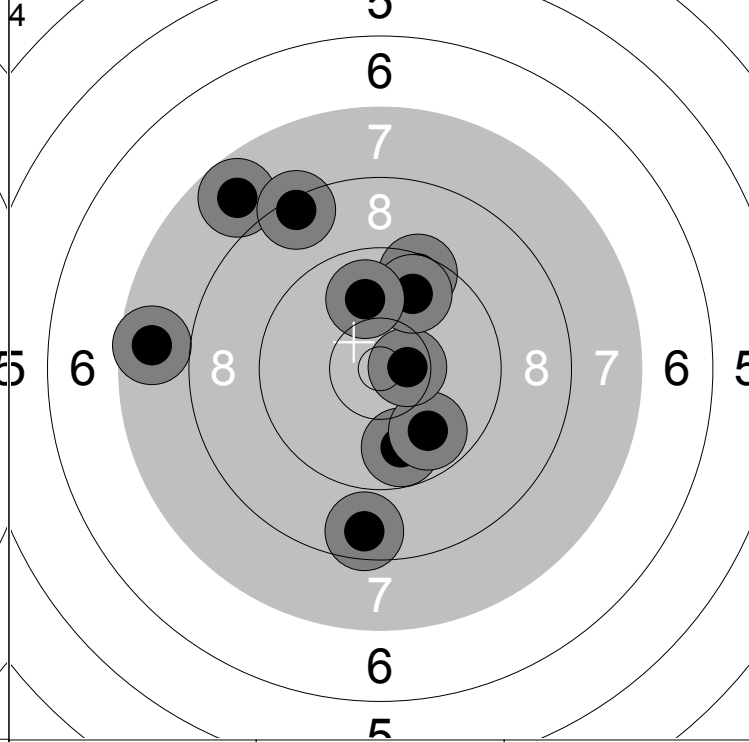

1: 9.8 ↓	6: 9.8 ↗	Series	91.9
2: 9.8 ↘	7: 9.9 ↑		
3: 9.5 ↗	8: 7.7 ←		371.6
4: 10.6x →	9: 8.4 ↖		
5: 7.8 ↖	10: 8.6 ↓		

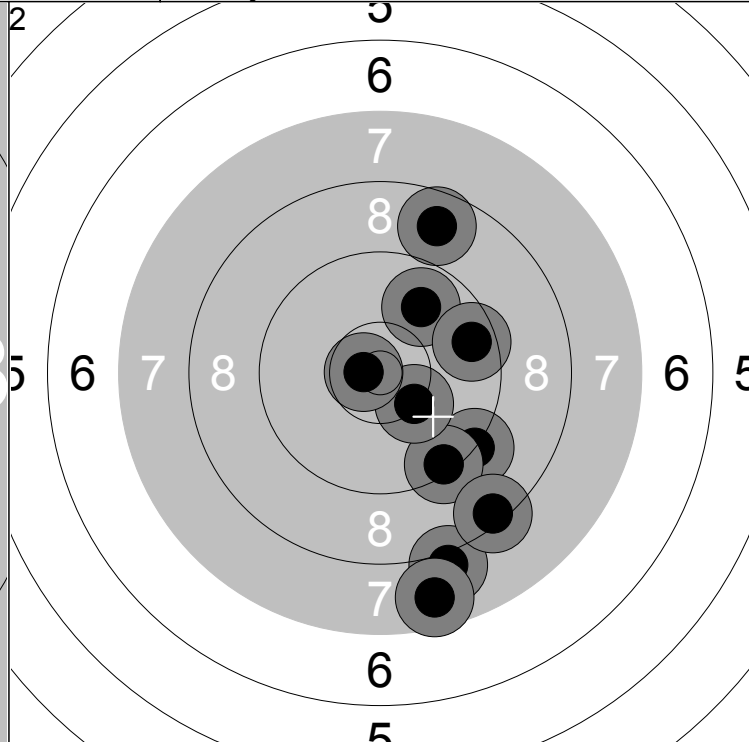
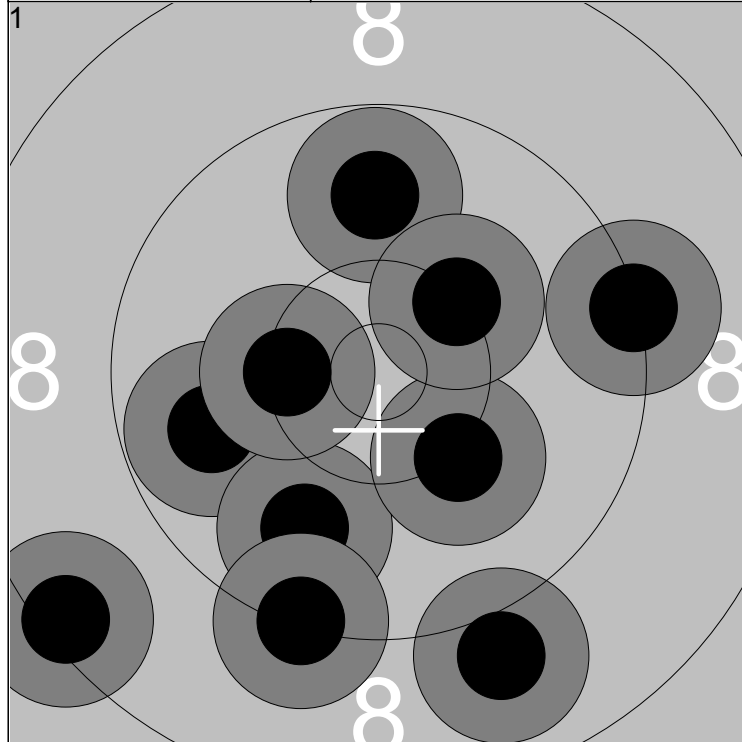

1: 9.3 →	6: 9.8 ↑	Series	96.3
2: 9.8 ←	7: 8.4 ↙		
3: 9.8 ↓	8: 9.0 ↓	96.3	
4: 10.2 ↓	9: 10.4x ←		
5: 9.3 ↓	10: 10.3 ↗		

1: 9.2 ↘	6: 9.4 ↘	Series	92.0
2: 8.7 ↗	7: 10.3 ↘		
3: 9.9 ↗	8: 10.7x ←	188.3	
4: 8.1 ↓	9: 8.4 ↓		
5: 9.6 →	10: 7.7 ↓		

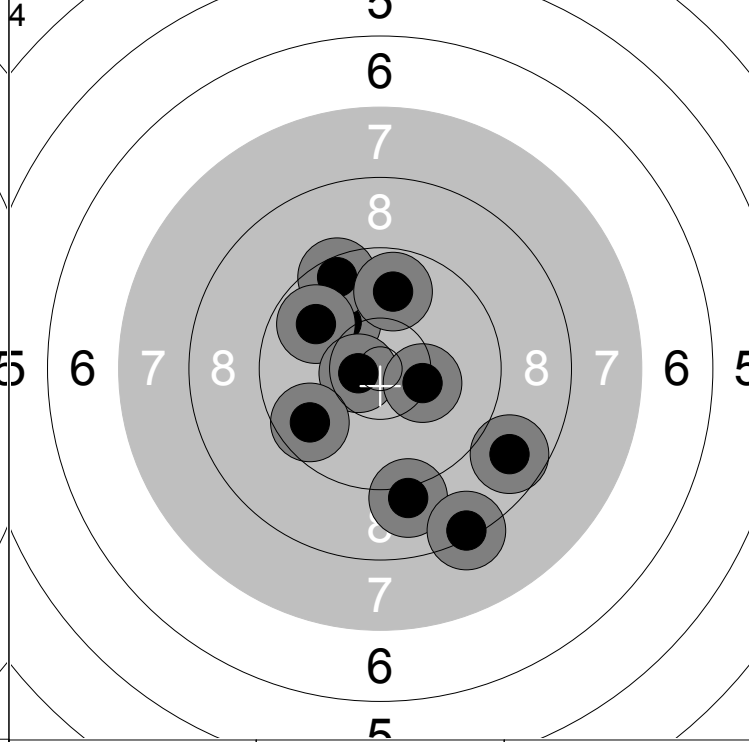
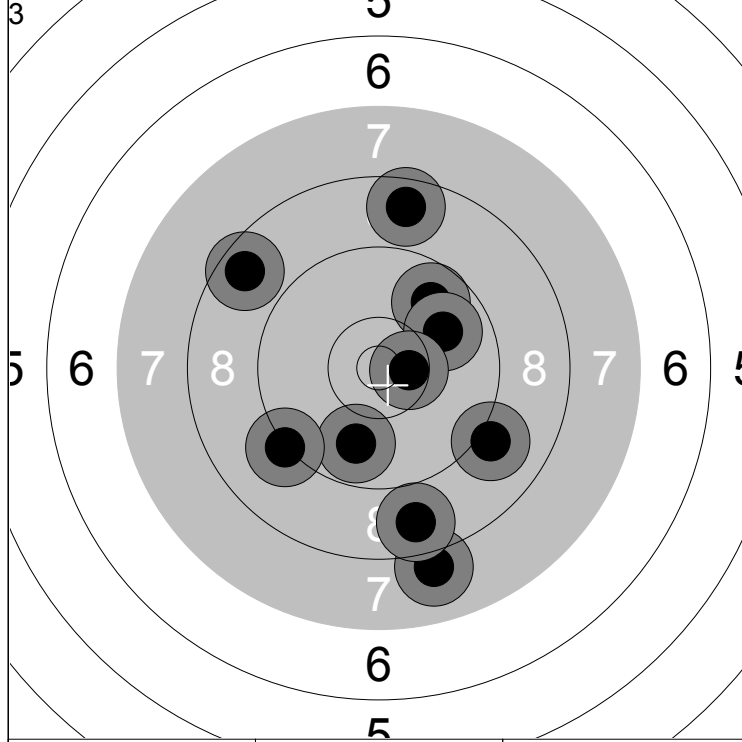

1: 8.6 ↑	6: 9.1 ↘	Series	92.2
2: 9.8 ↓	7: 8.7 ↓		
3: 8.0 ↓	8: 9.9 ↗	280.5	
4: 9.8 ↗	9: 10.5x →		
5: 8.6 ←	10: 9.2 ↙		

1: 10.1 ↗	6: 9.8 ↑	Series	95.9
2: 9.5 ↗	7: 10.6x ←		
3: 8.7 ↘	8: 10.3 →	376.4	
4: 9.8 ↗	9: 9.7 ↙		
5: 9.1 ↓	10: 8.3 ↓		