

<b>Sight</b> 	<table border="1" style="width:100%; border-collapse: collapse;"> <tr><td>1:</td><td>10.0</td><td>↘</td></tr> <tr><td>2:</td><td>9.3</td><td>↘</td></tr> <tr><td>3:</td><td>10.1</td><td>↘</td></tr> <tr><td>4:</td><td>10.3x</td><td>↘</td></tr> <tr><td>5:</td><td>10.1</td><td>↘</td></tr> <tr><td>6:</td><td>9.8</td><td>↘</td></tr> <tr><td>7:</td><td>9.8</td><td>↘</td></tr> <tr><td>8:</td><td>10.8x</td><td>↘</td></tr> <tr><td>9:</td><td>10.6x</td><td>↘</td></tr> <tr><td>10:</td><td>9.7</td><td>↘</td></tr> </table>	1:	10.0	↘	2:	9.3	↘	3:	10.1	↘	4:	10.3x	↘	5:	10.1	↘	6:	9.8	↘	7:	9.8	↘	8:	10.8x	↘	9:	10.6x	↘	10:	9.7	↘	<b>1. Series 1 Shots</b> 	<table border="1" style="width:100%; border-collapse: collapse;"> <tr><td>1:</td><td>10.5x</td><td>→</td></tr> </table>	1:	10.5x	→
1:	10.0	↘																																		
2:	9.3	↘																																		
3:	10.1	↘																																		
4:	10.3x	↘																																		
5:	10.1	↘																																		
6:	9.8	↘																																		
7:	9.8	↘																																		
8:	10.8x	↘																																		
9:	10.6x	↘																																		
10:	9.7	↘																																		
1:	10.5x	→																																		
<table border="1" style="width:100%; border-collapse: collapse;"> <tr><td style="width:80%;">Series</td><td style="width:20%; text-align: right;">100.5</td></tr> <tr><td></td><td style="text-align: right;">0.0</td></tr> </table>		Series	100.5		0.0	<table border="1" style="width:100%; border-collapse: collapse;"> <tr><td style="width:80%;">Series</td><td style="width:20%; text-align: right;">10.5</td></tr> <tr><td></td><td style="text-align: right;">10.5</td></tr> </table>		Series	10.5		10.5																									
Series	100.5																																			
	0.0																																			
Series	10.5																																			
	10.5																																			
<b>2. Series 1 Shots</b> 	<table border="1" style="width:100%; border-collapse: collapse;"> <tr><td>1:</td><td>10.0</td><td>→</td></tr> </table>	1:	10.0	→	<b>3. Series 1 Shots</b> 	<table border="1" style="width:100%; border-collapse: collapse;"> <tr><td>1:</td><td>10.3x</td><td>↘</td></tr> </table>	1:	10.3x	↘																											
1:	10.0	→																																		
1:	10.3x	↘																																		
<table border="1" style="width:100%; border-collapse: collapse;"> <tr><td style="width:80%;">Series</td><td style="width:20%; text-align: right;">10.0</td></tr> <tr><td></td><td style="text-align: right;">20.5</td></tr> </table>		Series	10.0		20.5	<table border="1" style="width:100%; border-collapse: collapse;"> <tr><td style="width:80%;">Series</td><td style="width:20%; text-align: right;">10.3</td></tr> <tr><td></td><td style="text-align: right;">30.8</td></tr> </table>		Series	10.3		30.8																									
Series	10.0																																			
	20.5																																			
Series	10.3																																			
	30.8																																			
<b>4. Series 1 Shots</b> 	<table border="1" style="width:100%; border-collapse: collapse;"> <tr><td>1:</td><td>10.7x</td><td>↘</td></tr> </table>	1:	10.7x	↘	<b>5. Series 1 Shots</b> 	<table border="1" style="width:100%; border-collapse: collapse;"> <tr><td>1:</td><td>10.2x</td><td>←</td></tr> </table>	1:	10.2x	←																											
1:	10.7x	↘																																		
1:	10.2x	←																																		
<table border="1" style="width:100%; border-collapse: collapse;"> <tr><td style="width:80%;">Series</td><td style="width:20%; text-align: right;">10.7</td></tr> <tr><td></td><td style="text-align: right;">41.5</td></tr> </table>		Series	10.7		41.5	<table border="1" style="width:100%; border-collapse: collapse;"> <tr><td style="width:80%;">Series</td><td style="width:20%; text-align: right;">10.2</td></tr> <tr><td></td><td style="text-align: right;">51.7</td></tr> </table>		Series	10.2		51.7																									
Series	10.7																																			
	41.5																																			
Series	10.2																																			
	51.7																																			
<b>6. Series 1 Shots</b> 	<table border="1" style="width:100%; border-collapse: collapse;"> <tr><td>1:</td><td>10.2x</td><td>←</td></tr> </table>	1:	10.2x	←	<b>7. Series 1 Shots</b> 	<table border="1" style="width:100%; border-collapse: collapse;"> <tr><td>1:</td><td>10.0</td><td>←</td></tr> </table>	1:	10.0	←																											
1:	10.2x	←																																		
1:	10.0	←																																		
<table border="1" style="width:100%; border-collapse: collapse;"> <tr><td style="width:80%;">Series</td><td style="width:20%; text-align: right;">10.2</td></tr> <tr><td></td><td style="text-align: right;">61.9</td></tr> </table>		Series	10.2		61.9	<table border="1" style="width:100%; border-collapse: collapse;"> <tr><td style="width:80%;">Series</td><td style="width:20%; text-align: right;">10.0</td></tr> <tr><td></td><td style="text-align: right;">71.9</td></tr> </table>		Series	10.0		71.9																									
Series	10.2																																			
	61.9																																			
Series	10.0																																			
	71.9																																			
<b>8. Series 1 Shots</b> 	<table border="1" style="width:100%; border-collapse: collapse;"> <tr><td>1:</td><td>10.3x</td><td>↗</td></tr> </table>	1:	10.3x	↗	<b>9. Series 1 Shots</b> 	<table border="1" style="width:100%; border-collapse: collapse;"> <tr><td>1:</td><td>9.7</td><td>↘</td></tr> </table>	1:	9.7	↘																											
1:	10.3x	↗																																		
1:	9.7	↘																																		
<table border="1" style="width:100%; border-collapse: collapse;"> <tr><td style="width:80%;">Series</td><td style="width:20%; text-align: right;">10.3</td></tr> <tr><td></td><td style="text-align: right;">82.2</td></tr> </table>		Series	10.3		82.2	<table border="1" style="width:100%; border-collapse: collapse;"> <tr><td style="width:80%;">Series</td><td style="width:20%; text-align: right;">9.7</td></tr> <tr><td></td><td style="text-align: right;">91.9</td></tr> </table>		Series	9.7		91.9																									
Series	10.3																																			
	82.2																																			
Series	9.7																																			
	91.9																																			
<b>10. Series 1 Shots</b> 	<table border="1" style="width:100%; border-collapse: collapse;"> <tr><td>1:</td><td>9.9</td><td>←</td></tr> </table>	1:	9.9	←	<b>11. Series 1 Shots</b> 	<table border="1" style="width:100%; border-collapse: collapse;"> <tr><td>1:</td><td>10.2x</td><td>↖</td></tr> </table>	1:	10.2x	↖																											
1:	9.9	←																																		
1:	10.2x	↖																																		
<table border="1" style="width:100%; border-collapse: collapse;"> <tr><td style="width:80%;">Series</td><td style="width:20%; text-align: right;">9.9</td></tr> <tr><td></td><td style="text-align: right;">101.8</td></tr> </table>		Series	9.9		101.8	<table border="1" style="width:100%; border-collapse: collapse;"> <tr><td style="width:80%;">Series</td><td style="width:20%; text-align: right;">10.2</td></tr> <tr><td></td><td style="text-align: right;">112.0</td></tr> </table>		Series	10.2		112.0																									
Series	9.9																																			
	101.8																																			
Series	10.2																																			
	112.0																																			

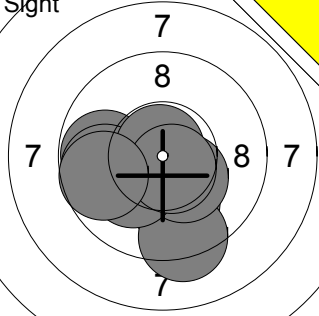

1: 10.8x ↗

Series	10.8
	122.8

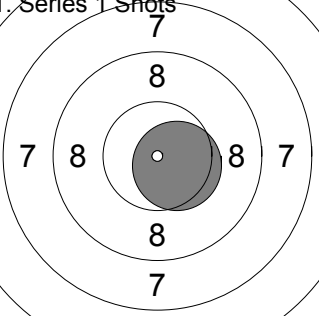
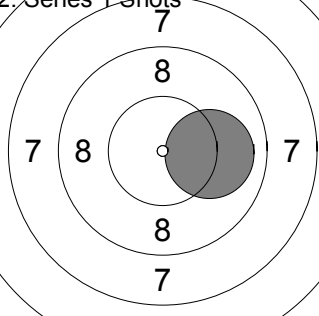
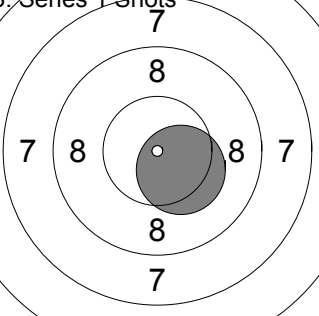
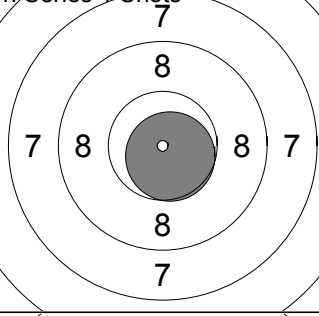
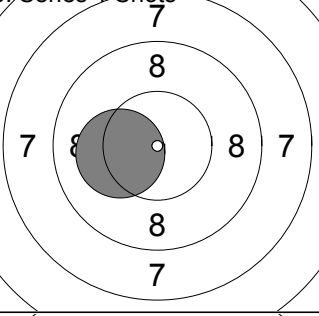
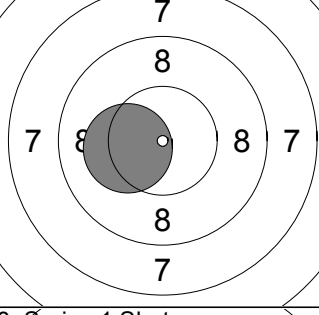
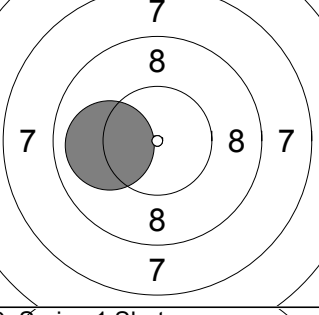
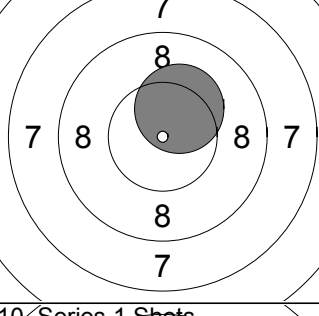
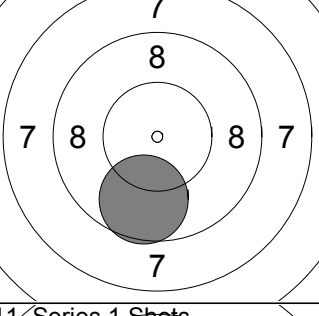
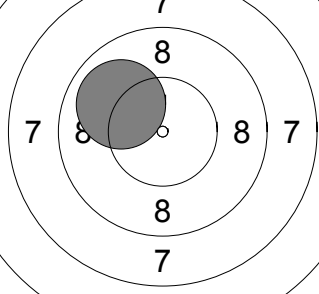
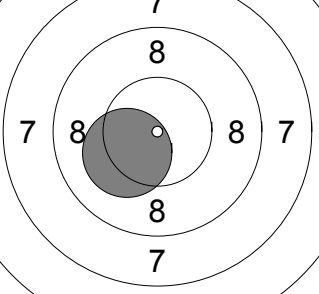
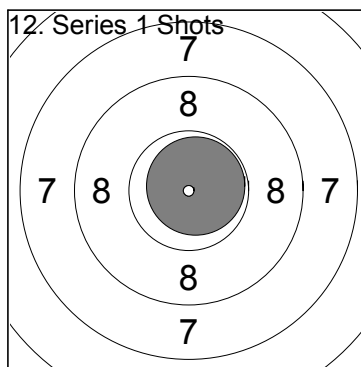
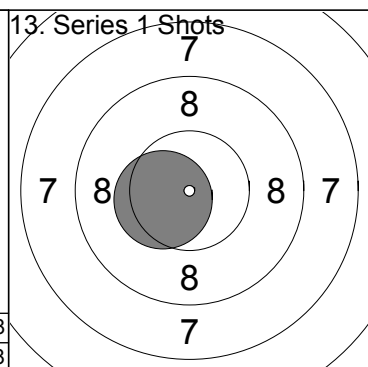

1: 10.4x ←

Series	10.4
	133.2

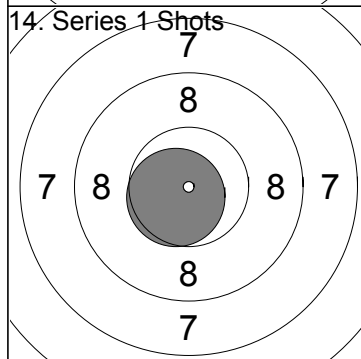

1: 10.6x ↙

Series	10.6
	143.8

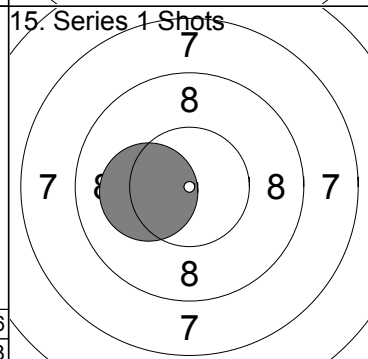

1: 10.2x ←

Series	10.2
	154.0

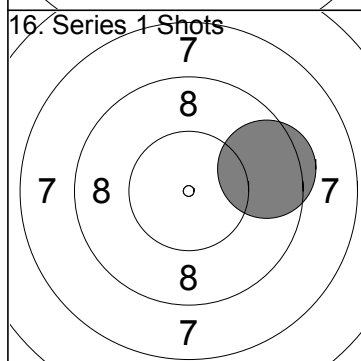

1: 9.5 →

Series	9.5
	163.5

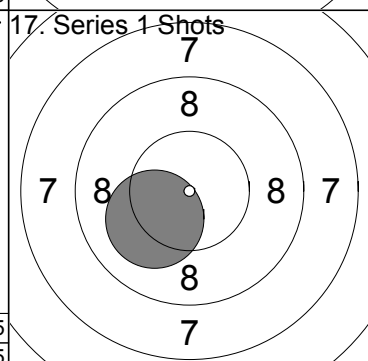

1: 10.1 ↖

Series	10.1
	173.6

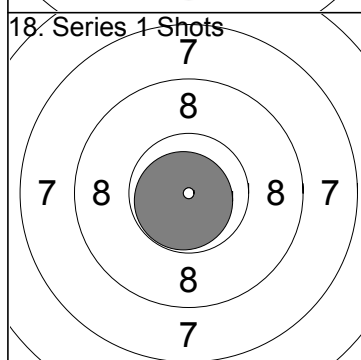

1: 10.8x ↙

Series	10.8
	184.4

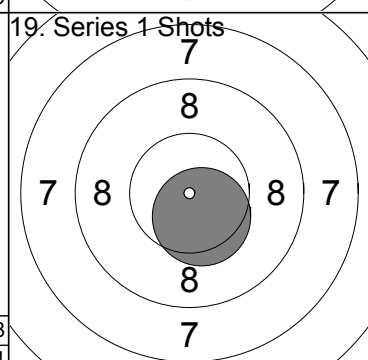

1: 10.5x ↘

Series	10.5
	194.9

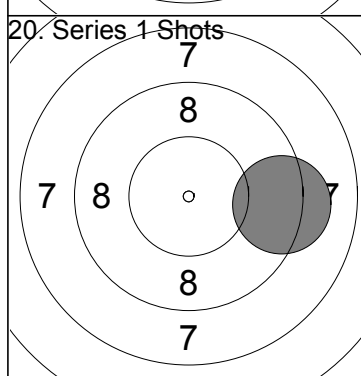

1: 9.2 →

Series	9.2
	204.1

--	--

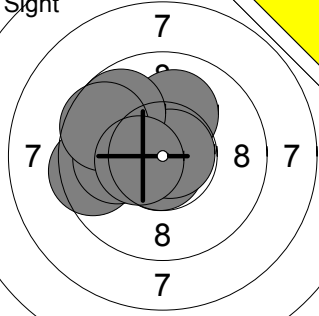
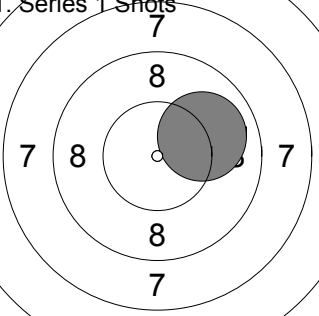
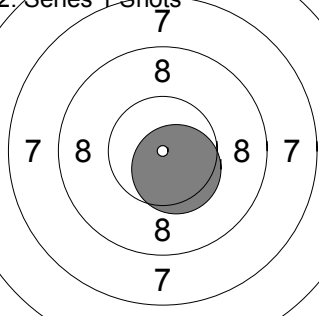
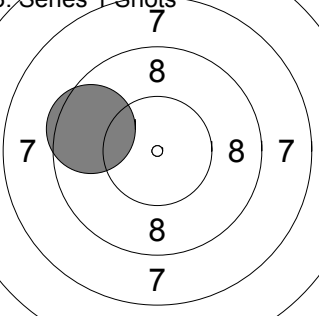
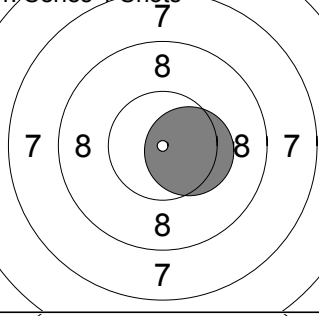
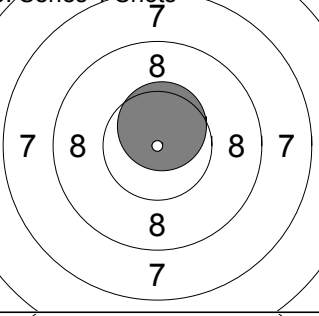
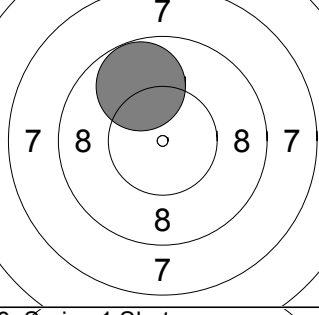
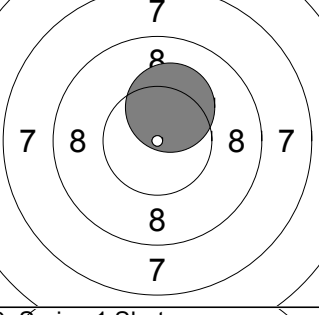
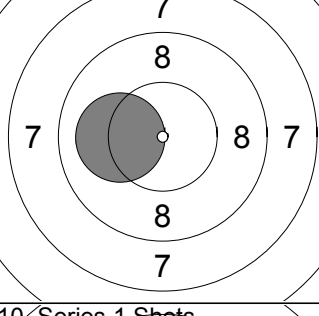
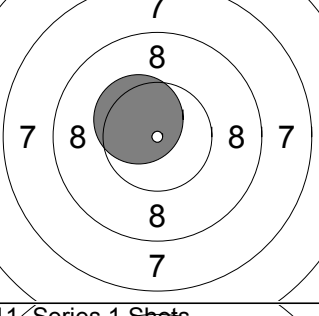
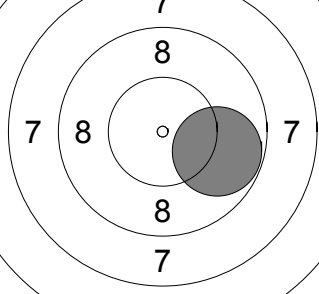
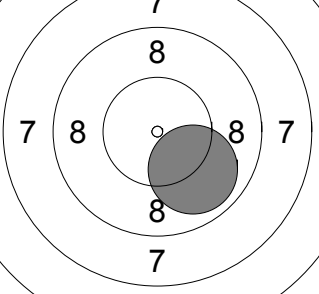
<b>Sight</b> 	<table style="width:100%; border-collapse: collapse;"> <tr><td style="width:50%;">1: 9.5</td><td style="width:50%; text-align:right;">←</td></tr> <tr><td>2: 10.1</td><td style="text-align:right;">↑</td></tr> <tr><td>3: 10.0</td><td style="text-align:right;">←</td></tr> <tr><td>4: 10.7x</td><td style="text-align:right;">↓</td></tr> <tr><td>5: 10.8x</td><td style="text-align:right;">→</td></tr> <tr><td>6: 9.7</td><td style="text-align:right;">↑</td></tr> <tr><td>7: 9.6</td><td style="text-align:right;">↑</td></tr> <tr><td>8: 10.5x</td><td style="text-align:right;">←</td></tr> </table>	1: 9.5	←	2: 10.1	↑	3: 10.0	←	4: 10.7x	↓	5: 10.8x	→	6: 9.7	↑	7: 9.6	↑	8: 10.5x	←	<b>1. Series 1 Shots</b> 	<table style="width:100%; border-collapse: collapse;"> <tr><td style="width:50%;">1: 10.0</td><td style="width:50%; text-align:right;">↗</td></tr> </table>	1: 10.0	↗
1: 9.5	←																				
2: 10.1	↑																				
3: 10.0	←																				
4: 10.7x	↓																				
5: 10.8x	→																				
6: 9.7	↑																				
7: 9.6	↑																				
8: 10.5x	←																				
1: 10.0	↗																				
	<table style="width:100%; border-collapse: collapse;"> <tr><td style="width:50%;">Series</td><td style="width:50%; text-align:right;">80.9</td></tr> <tr><td></td><td style="text-align:right;">0.0</td></tr> </table>	Series	80.9		0.0		<table style="width:100%; border-collapse: collapse;"> <tr><td style="width:50%;">Series</td><td style="width:50%; text-align:right;">10.0</td></tr> <tr><td></td><td style="text-align:right;">10.0</td></tr> </table>	Series	10.0		10.0										
Series	80.9																				
	0.0																				
Series	10.0																				
	10.0																				
<b>2. Series 1 Shots</b> 	<table style="width:100%; border-collapse: collapse;"> <tr><td style="width:50%;">1: 10.5x</td><td style="width:50%; text-align:right;">↘</td></tr> </table>	1: 10.5x	↘	<b>3. Series 1 Shots</b> 	<table style="width:100%; border-collapse: collapse;"> <tr><td style="width:50%;">1: 9.5</td><td style="width:50%; text-align:right;">←</td></tr> </table>	1: 9.5	←														
1: 10.5x	↘																				
1: 9.5	←																				
	<table style="width:100%; border-collapse: collapse;"> <tr><td style="width:50%;">Series</td><td style="width:50%; text-align:right;">10.5</td></tr> <tr><td></td><td style="text-align:right;">20.5</td></tr> </table>	Series	10.5		20.5		<table style="width:100%; border-collapse: collapse;"> <tr><td style="width:50%;">Series</td><td style="width:50%; text-align:right;">9.5</td></tr> <tr><td></td><td style="text-align:right;">30.0</td></tr> </table>	Series	9.5		30.0										
Series	10.5																				
	20.5																				
Series	9.5																				
	30.0																				
<b>4. Series 1 Shots</b> 	<table style="width:100%; border-collapse: collapse;"> <tr><td style="width:50%;">1: 10.4x</td><td style="width:50%; text-align:right;">→</td></tr> </table>	1: 10.4x	→	<b>5. Series 1 Shots</b> 	<table style="width:100%; border-collapse: collapse;"> <tr><td style="width:50%;">1: 10.6x</td><td style="width:50%; text-align:right;">↑</td></tr> </table>	1: 10.6x	↑														
1: 10.4x	→																				
1: 10.6x	↑																				
	<table style="width:100%; border-collapse: collapse;"> <tr><td style="width:50%;">Series</td><td style="width:50%; text-align:right;">10.4</td></tr> <tr><td></td><td style="text-align:right;">40.4</td></tr> </table>	Series	10.4		40.4		<table style="width:100%; border-collapse: collapse;"> <tr><td style="width:50%;">Series</td><td style="width:50%; text-align:right;">10.6</td></tr> <tr><td></td><td style="text-align:right;">51.0</td></tr> </table>	Series	10.6		51.0										
Series	10.4																				
	40.4																				
Series	10.6																				
	51.0																				
<b>6. Series 1 Shots</b> 	<table style="width:100%; border-collapse: collapse;"> <tr><td style="width:50%;">1: 9.8</td><td style="width:50%; text-align:right;">↑</td></tr> </table>	1: 9.8	↑	<b>7. Series 1 Shots</b> 	<table style="width:100%; border-collapse: collapse;"> <tr><td style="width:50%;">1: 10.2x</td><td style="width:50%; text-align:right;">↑</td></tr> </table>	1: 10.2x	↑														
1: 9.8	↑																				
1: 10.2x	↑																				
	<table style="width:100%; border-collapse: collapse;"> <tr><td style="width:50%;">Series</td><td style="width:50%; text-align:right;">9.8</td></tr> <tr><td></td><td style="text-align:right;">60.8</td></tr> </table>	Series	9.8		60.8		<table style="width:100%; border-collapse: collapse;"> <tr><td style="width:50%;">Series</td><td style="width:50%; text-align:right;">10.2</td></tr> <tr><td></td><td style="text-align:right;">71.0</td></tr> </table>	Series	10.2		71.0										
Series	9.8																				
	60.8																				
Series	10.2																				
	71.0																				
<b>8. Series 1 Shots</b> 	<table style="width:100%; border-collapse: collapse;"> <tr><td style="width:50%;">1: 10.1</td><td style="width:50%; text-align:right;">←</td></tr> </table>	1: 10.1	←	<b>9. Series 1 Shots</b> 	<table style="width:100%; border-collapse: collapse;"> <tr><td style="width:50%;">1: 10.4x</td><td style="width:50%; text-align:right;">↖</td></tr> </table>	1: 10.4x	↖														
1: 10.1	←																				
1: 10.4x	↖																				
	<table style="width:100%; border-collapse: collapse;"> <tr><td style="width:50%;">Series</td><td style="width:50%; text-align:right;">10.1</td></tr> <tr><td></td><td style="text-align:right;">81.1</td></tr> </table>	Series	10.1		81.1		<table style="width:100%; border-collapse: collapse;"> <tr><td style="width:50%;">Series</td><td style="width:50%; text-align:right;">10.4</td></tr> <tr><td></td><td style="text-align:right;">91.5</td></tr> </table>	Series	10.4		91.5										
Series	10.1																				
	81.1																				
Series	10.4																				
	91.5																				
<b>10. Series 1 Shots</b> 	<table style="width:100%; border-collapse: collapse;"> <tr><td style="width:50%;">1: 9.8</td><td style="width:50%; text-align:right;">→</td></tr> </table>	1: 9.8	→	<b>11. Series 1 Shots</b> 	<table style="width:100%; border-collapse: collapse;"> <tr><td style="width:50%;">1: 9.9</td><td style="width:50%; text-align:right;">↘</td></tr> </table>	1: 9.9	↘														
1: 9.8	→																				
1: 9.9	↘																				
	<table style="width:100%; border-collapse: collapse;"> <tr><td style="width:50%;">Series</td><td style="width:50%; text-align:right;">9.8</td></tr> <tr><td></td><td style="text-align:right;">101.3</td></tr> </table>	Series	9.8		101.3		<table style="width:100%; border-collapse: collapse;"> <tr><td style="width:50%;">Series</td><td style="width:50%; text-align:right;">9.9</td></tr> <tr><td></td><td style="text-align:right;">111.2</td></tr> </table>	Series	9.9		111.2										
Series	9.8																				
	101.3																				
Series	9.9																				
	111.2																				

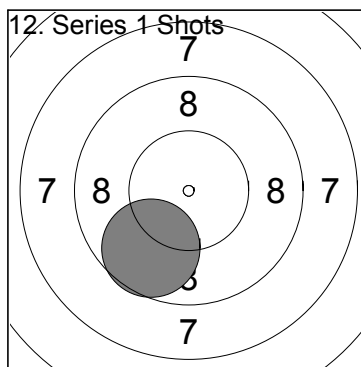

1: 9.7 ↙

Series	9.7
	120.9

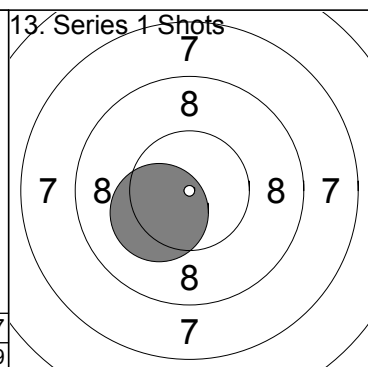

1: 10.3x ↖

Series	10.3
	131.2

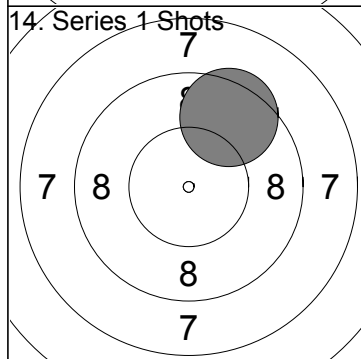

1: 9.5 ↗

Series	9.5
	140.7

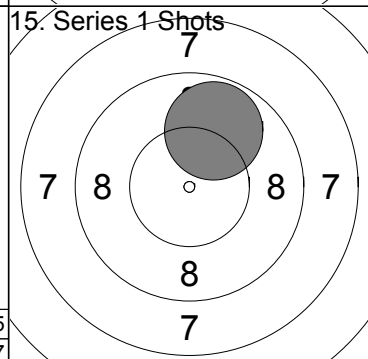

1: 9.8 ↗

Series	9.8
	150.5

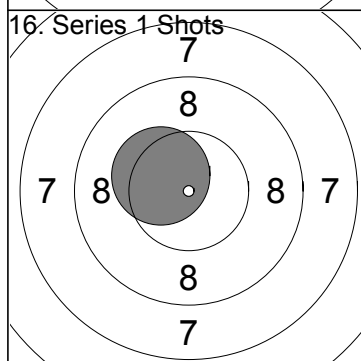

1: 10.4x ↖

Series	10.4
	160.9

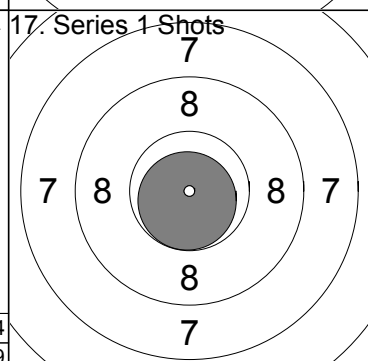

1: 10.8x ↘

Series	10.8
	171.7

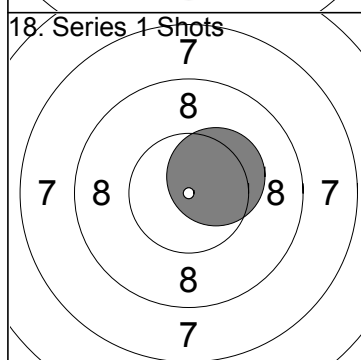

1: 10.4x ↗

Series	10.4
	182.1

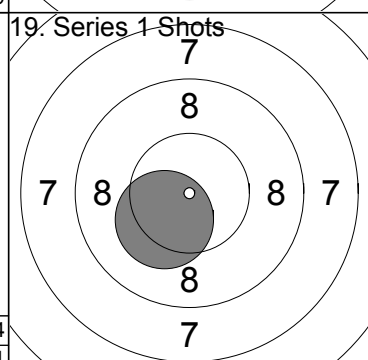

1: 10.3x ↖

Series	10.3
	192.4

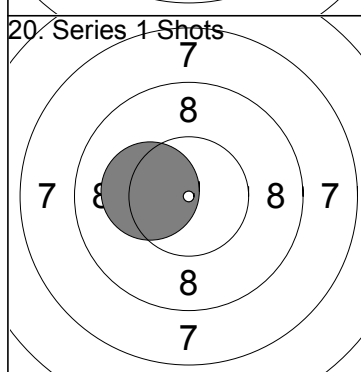

1: 10.2x ↖

Series	10.2
	202.6

--	--

<b>Sight</b> 	1: 10.2x 2: 9.8 3: 10.1 4: 10.4x 5: 10.5x 6: 10.2x 7: 10.2x 8: 10.4x ↓ ↙ ↘ → ↓ ← ↙ ↘ ↗	<b>1. Series 1 Shots</b> 	1: 10.1 ↘
	Series 81.8 0.0		Series 10.1 10.1
<b>2. Series 1 Shots</b> 	1: 10.3x ←	<b>3. Series 1 Shots</b> 	1: 10.2x →
	Series 10.3 20.4		Series 10.2 30.6
<b>4. Series 1 Shots</b> 	1: 10.5x ↙	<b>5. Series 1 Shots</b> 	1: 10.4x →
	Series 10.5 41.1		Series 10.4 51.5
<b>6. Series 1 Shots</b> 	1: 10.8x ↘	<b>7. Series 1 Shots</b> 	1: 10.3x →
	Series 10.8 62.3		Series 10.3 72.6
<b>8. Series 1 Shots</b> 	1: 9.9 →	<b>9. Series 1 Shots</b> 	1: 10.0 ↗
	Series 9.9 82.5		Series 10.0 92.5
<b>10. Series 1 Shots</b> 	1: 10.3x ↗	<b>11. Series 1 Shots</b> 	1: 9.9 ↓
	Series 10.3 102.8		Series 9.9 112.7

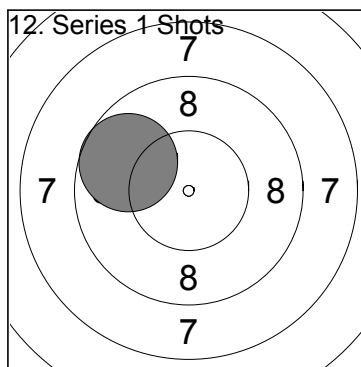

1: 9.7 ←

Series	9.7
	122.4

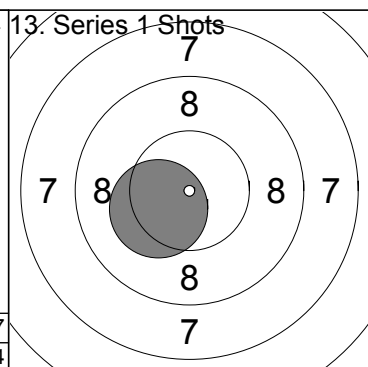

1: 10.3x ↖

Series	10.3
	132.7

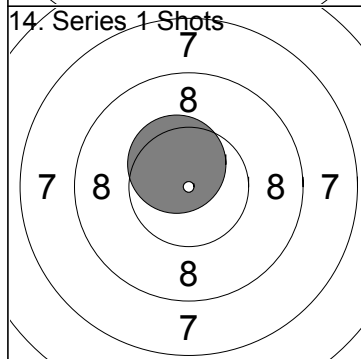

1: 10.5x ↗

Series	10.5
	143.2

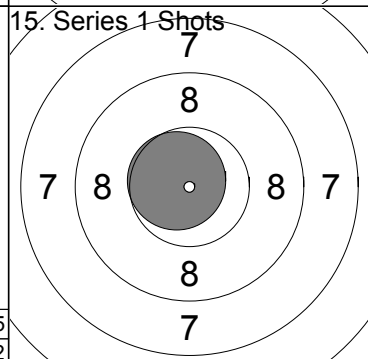

1: 10.7x ↖

Series	10.7
	153.9

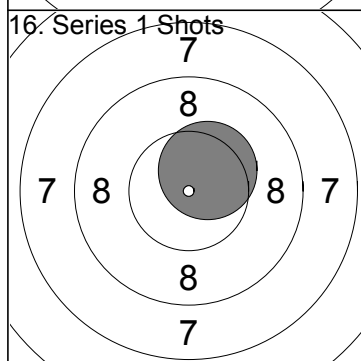

1: 10.4x ↗

Series	10.4
	164.3

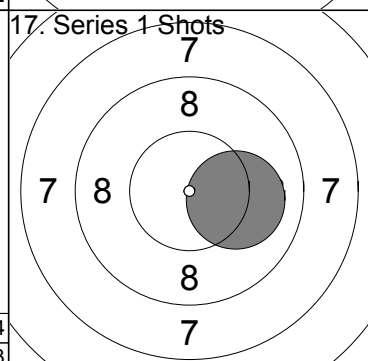

1: 10.1 →

Series	10.1
	174.4

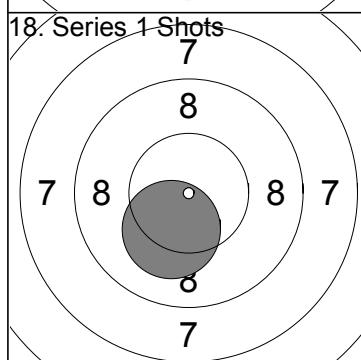

1: 10.2x ↘

Series	10.2
	184.6

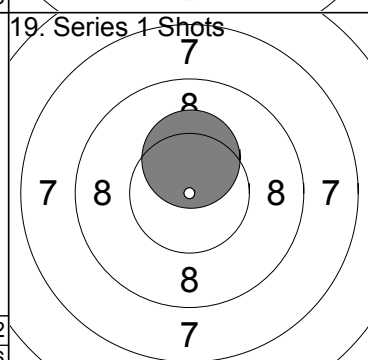

1: 10.3x ↑

Series	10.3
	194.9

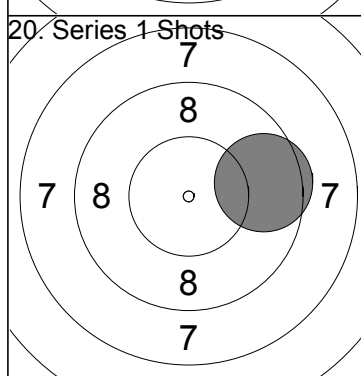

1: 9.6 →

Series	9.6
	204.5

--	--

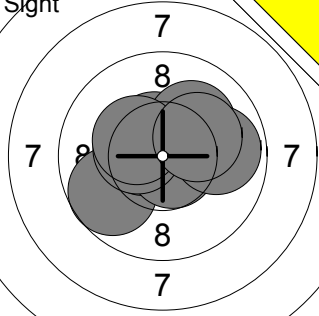
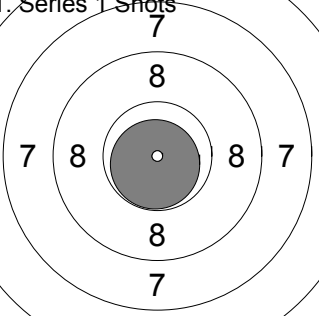
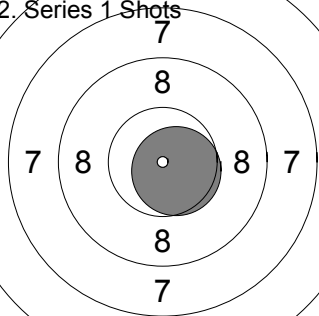
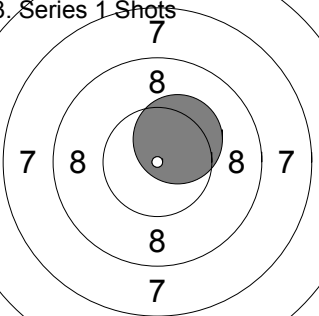
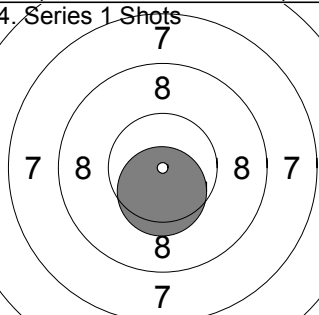
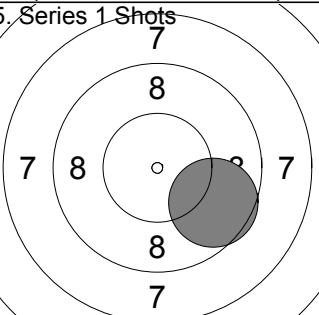
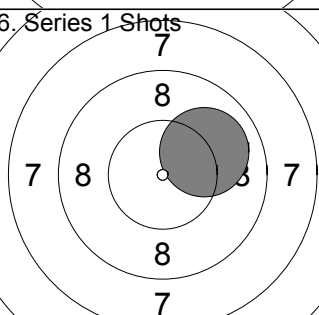
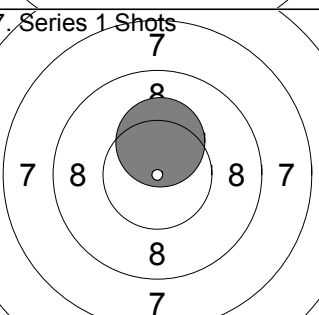
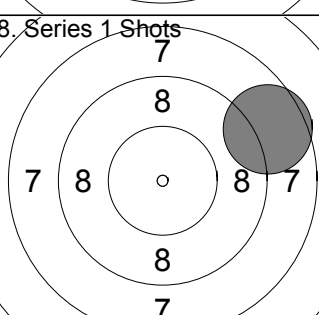
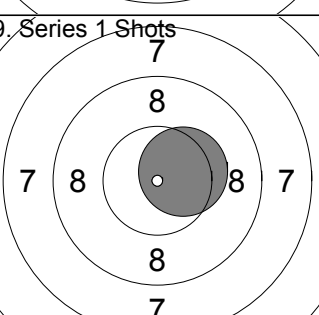
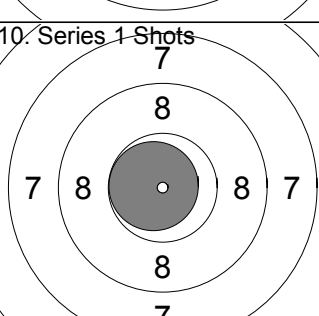
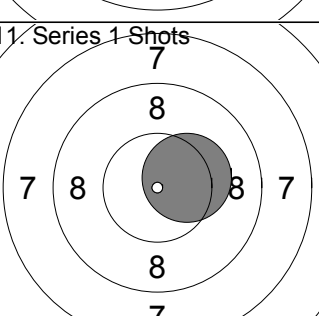
Sight 	1: 9.7 2: 10.6x 3: 10.5x 4: 10.7x 5: 10.1 6: 10.4x 7: 9.9 8: 10.3x 9: 10.1 Series 92.3 0.0	1. Series 1 Shots 	1: 10.8x Series 10.8 10.8
2. Series 1 Shots 	1: 10.6x Series 10.6 21.4	3. Series 1 Shots 	1: 10.3x Series 10.3 31.7
4. Series 1 Shots 	1: 10.5x Series 10.5 42.2	5. Series 1 Shots 	1: 9.6 Series 9.6 51.8
6. Series 1 Shots 	1: 10.0 Series 10.0 61.8	7. Series 1 Shots 	1: 10.3x Series 10.3 72.1
8. Series 1 Shots 	1: 8.6 Series 8.6 80.7	9. Series 1 Shots 	1: 10.4x Series 10.4 91.1
10. Series 1 Shots 	1: 10.8x Series 10.8 101.9	11. Series 1 Shots 	1: 10.3x Series 10.3 112.2

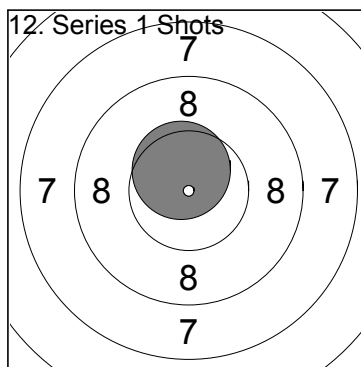

1: 10.6x ↑

Series	10.6
	122.8

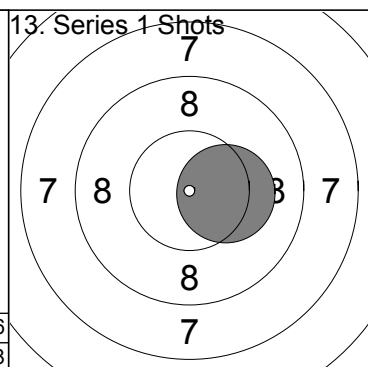

1: 10.3x →

Series	10.3
	133.1

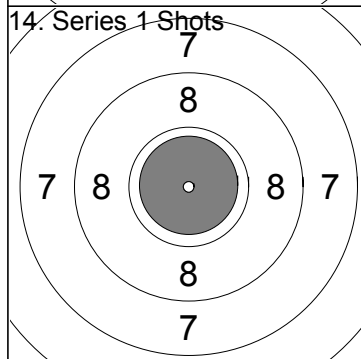

1: 10.9x ↑

Series	10.9
	144.0

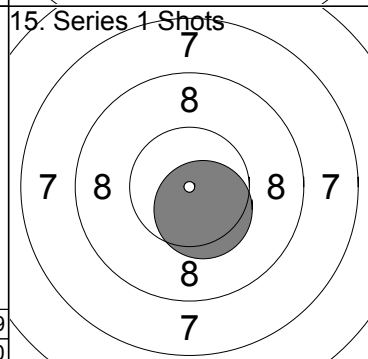

1: 10.5x ↓

Series	10.5
	154.5

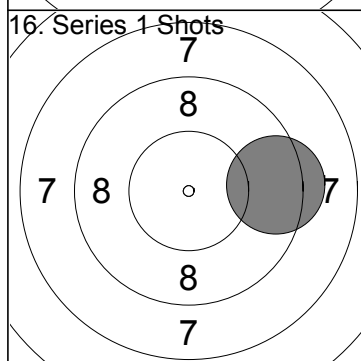

1: 9.4 →

Series	9.4
	163.9

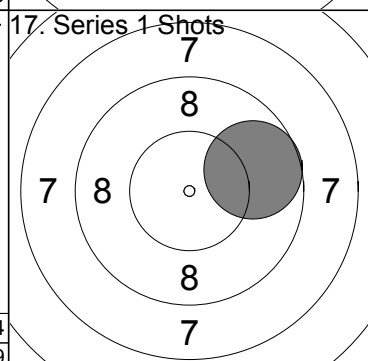

1: 9.7 →

Series	9.7
	173.6

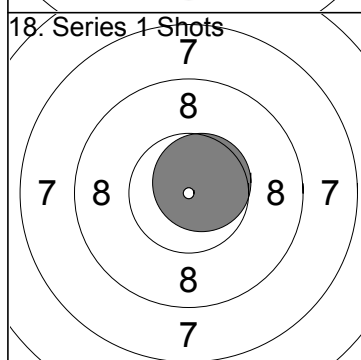

1: 10.6x ↗

Series	10.6
	184.2

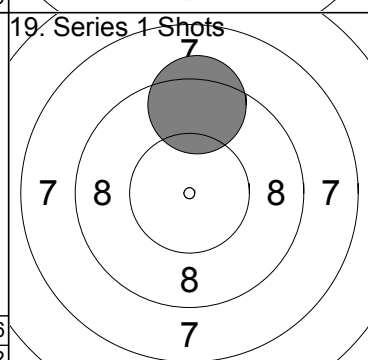

1: 9.3 ↑

Series	9.3
	193.5

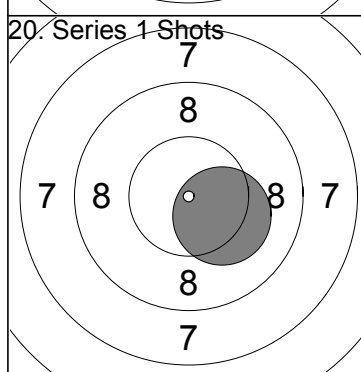

1: 10.2x ↘

Series	10.2
	203.7

--	--

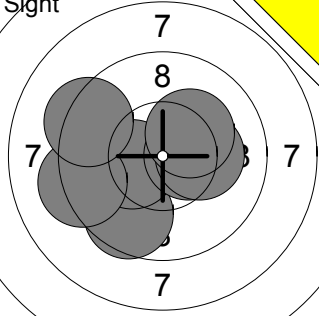
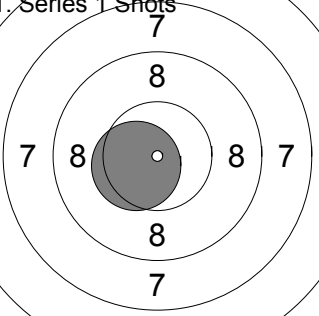
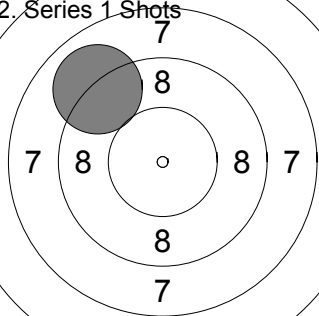
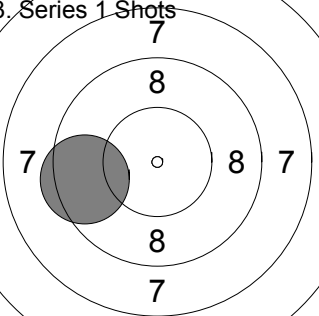
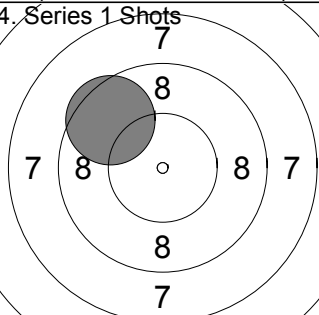
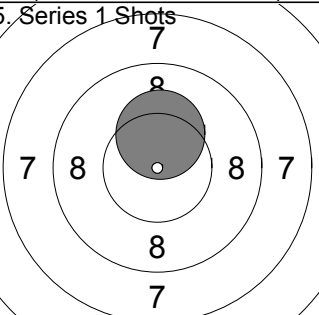
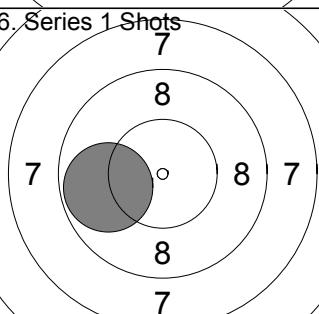
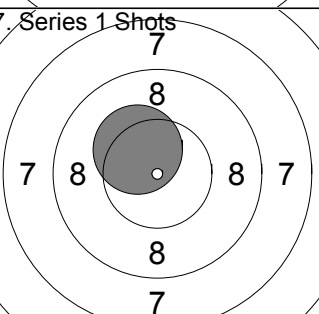
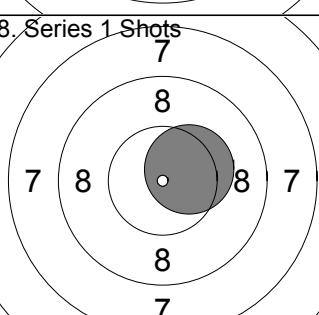
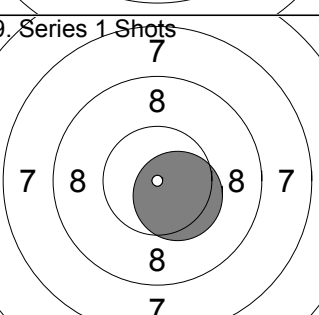
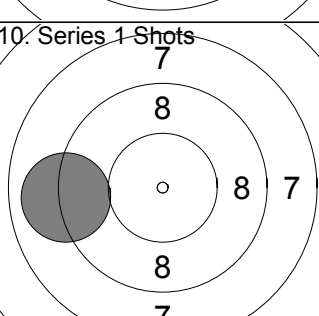
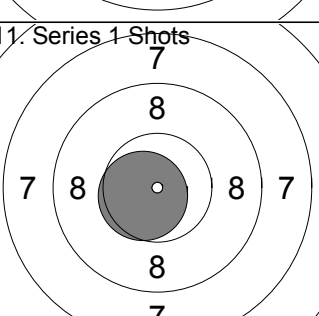

Sight 	1: 9.6 2: 10.3x 3: 10.4x 4: 10.2x 5: 10.2x 6: 9.2 7: 9.3 ↙ ↘ ← → ↗ ↖ ↙ ↘	1. Series 1 Shots 	1: 10.5x ↙
	Series 69.2 0.0		Series 10.5 10.5
2. Series 1 Shots 	1: 9.0 ↖	3. Series 1 Shots 	1: 9.4 ←
	Series 9.0 19.5		Series 9.4 28.9
4. Series 1 Shots 	1: 9.5 ↖	5. Series 1 Shots 	1: 10.3x ↑
	Series 9.5 38.4		Series 10.3 48.7
6. Series 1 Shots 	1: 9.8 ←	7. Series 1 Shots 	1: 10.3x ↖
	Series 9.8 58.5		Series 10.3 68.8
8. Series 1 Shots 	1: 10.4x →	9. Series 1 Shots 	1: 10.4x ↘
	Series 10.4 79.2		Series 10.4 89.6
10. Series 1 Shots 	1: 9.0 ←	11. Series 1 Shots 	1: 10.6x ↙
	Series 9.0 98.6		Series 10.6 109.2

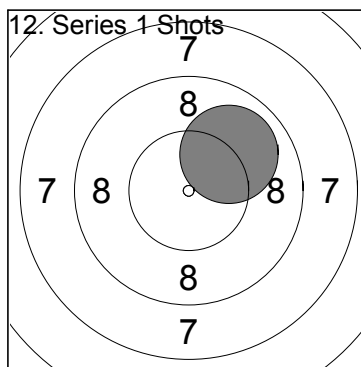

1: 10.0 ↗

Series	10.0
	119.2

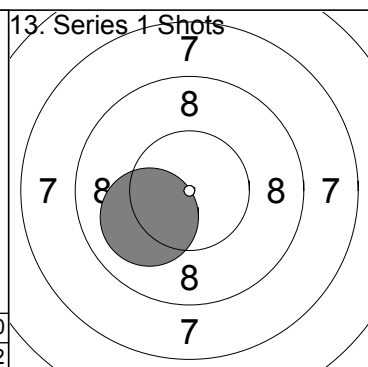

1: 10.1 ↖

Series	10.1
	129.3

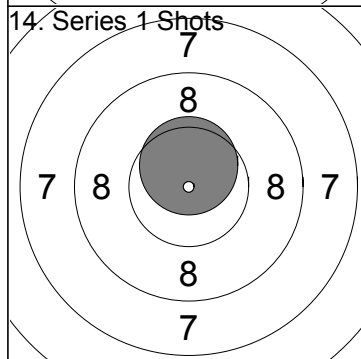

1: 10.6x ↑

Series	10.6
	139.9

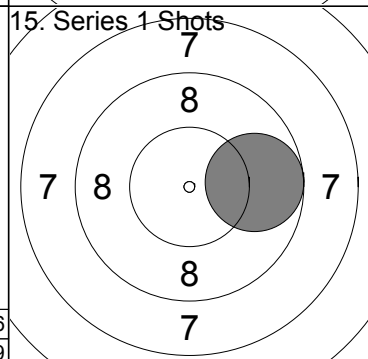

1: 9.8 →

Series	9.8
	149.7

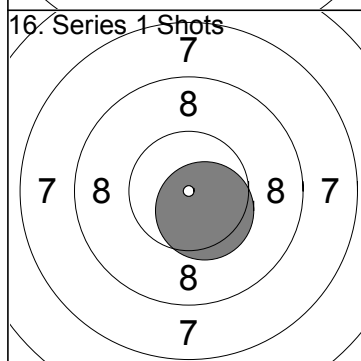

1: 10.5x ↘

Series	10.5
	160.2

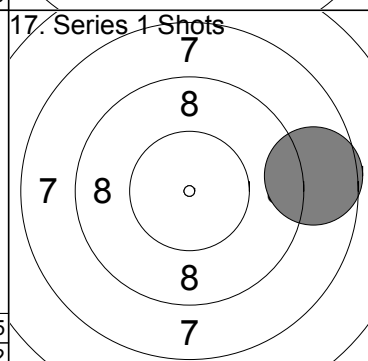

1: 8.7 →

Series	8.7
	168.9

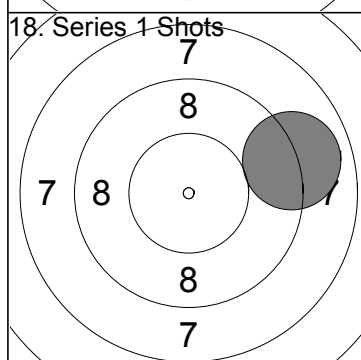

1: 9.0 →

Series	9.0
	177.9

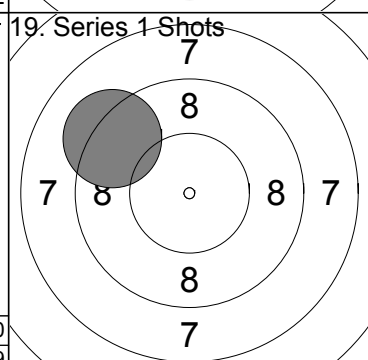

1: 9.2 ↖

Series	9.2
	187.1

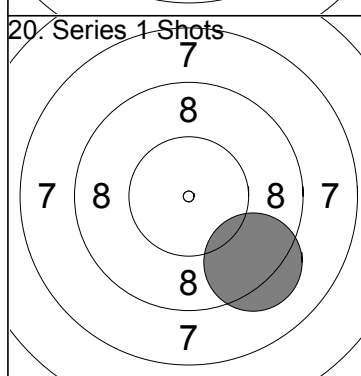

1: 9.3 ↘

Series	9.3
	196.4

--	--

<p>Sight</p>	<table style="width:100%; border-collapse: collapse;"> <tr><td>1:</td><td>9.9</td><td>←</td></tr> <tr><td>2:</td><td>9.7</td><td>↙</td></tr> <tr><td>3:</td><td>9.6</td><td>↘</td></tr> <tr><td>4:</td><td>10.4x</td><td>↓</td></tr> <tr><td>5:</td><td>8.9</td><td>↙</td></tr> <tr><td>6:</td><td>9.5</td><td>↘</td></tr> <tr><td>7:</td><td>8.8</td><td>↙</td></tr> <tr><td>8:</td><td>10.1</td><td>↘</td></tr> <tr><td>9:</td><td>10.5x</td><td>→</td></tr> <tr><td>10:</td><td>10.4x</td><td>←</td></tr> </table>	1:	9.9	←	2:	9.7	↙	3:	9.6	↘	4:	10.4x	↓	5:	8.9	↙	6:	9.5	↘	7:	8.8	↙	8:	10.1	↘	9:	10.5x	→	10:	10.4x	←	<p>Sight</p>	<table style="width:100%; border-collapse: collapse;"> <tr><td>11:</td><td>9.4</td><td>←</td></tr> </table>	11:	9.4	←
1:	9.9	←																																		
2:	9.7	↙																																		
3:	9.6	↘																																		
4:	10.4x	↓																																		
5:	8.9	↙																																		
6:	9.5	↘																																		
7:	8.8	↙																																		
8:	10.1	↘																																		
9:	10.5x	→																																		
10:	10.4x	←																																		
11:	9.4	←																																		
	<table style="width:100%; border-collapse: collapse;"> <tr><td style="width:50%;">Series</td><td style="width:50%; text-align:right;">97.8</td></tr> <tr><td></td><td style="text-align:right;">0.0</td></tr> </table>	Series	97.8		0.0		<table style="width:100%; border-collapse: collapse;"> <tr><td style="width:50%;">Series</td><td style="width:50%; text-align:right;">9.4</td></tr> <tr><td></td><td style="text-align:right;">0.0</td></tr> </table>	Series	9.4		0.0																									
Series	97.8																																			
	0.0																																			
Series	9.4																																			
	0.0																																			

<p>1. Series 1 Shots</p>	<table style="width:100%; border-collapse: collapse;"> <tr><td>1:</td><td>10.5x</td><td>↖</td></tr> </table>	1:	10.5x	↖	<p>2. Series 1 Shots</p>	<table style="width:100%; border-collapse: collapse;"> <tr><td>1:</td><td>10.0</td><td>↓</td></tr> </table>	1:	10.0	↓		
1:	10.5x	↖									
1:	10.0	↓									
	<table style="width:100%; border-collapse: collapse;"> <tr><td style="width:50%;">Series</td><td style="width:50%; text-align:right;">10.5</td></tr> <tr><td></td><td style="text-align:right;">10.5</td></tr> </table>	Series	10.5		10.5		<table style="width:100%; border-collapse: collapse;"> <tr><td style="width:50%;">Series</td><td style="width:50%; text-align:right;">10.0</td></tr> <tr><td></td><td style="text-align:right;">20.5</td></tr> </table>	Series	10.0		20.5
Series	10.5										
	10.5										
Series	10.0										
	20.5										

<p>3. Series 1 Shots</p>	<table style="width:100%; border-collapse: collapse;"> <tr><td>1:</td><td>10.1</td><td>↑</td></tr> </table>	1:	10.1	↑	<p>4. Series 1 Shots</p>	<table style="width:100%; border-collapse: collapse;"> <tr><td>1:</td><td>10.3x</td><td>↖</td></tr> </table>	1:	10.3x	↖		
1:	10.1	↑									
1:	10.3x	↖									
	<table style="width:100%; border-collapse: collapse;"> <tr><td style="width:50%;">Series</td><td style="width:50%; text-align:right;">10.1</td></tr> <tr><td></td><td style="text-align:right;">30.6</td></tr> </table>	Series	10.1		30.6		<table style="width:100%; border-collapse: collapse;"> <tr><td style="width:50%;">Series</td><td style="width:50%; text-align:right;">10.3</td></tr> <tr><td></td><td style="text-align:right;">40.9</td></tr> </table>	Series	10.3		40.9
Series	10.1										
	30.6										
Series	10.3										
	40.9										

<p>5. Series 1 Shots</p>	<table style="width:100%; border-collapse: collapse;"> <tr><td>1:</td><td>9.8</td><td>↙</td></tr> </table>	1:	9.8	↙	<p>6. Series 1 Shots</p>	<table style="width:100%; border-collapse: collapse;"> <tr><td>1:</td><td>10.0</td><td>↙</td></tr> </table>	1:	10.0	↙		
1:	9.8	↙									
1:	10.0	↙									
	<table style="width:100%; border-collapse: collapse;"> <tr><td style="width:50%;">Series</td><td style="width:50%; text-align:right;">9.8</td></tr> <tr><td></td><td style="text-align:right;">50.7</td></tr> </table>	Series	9.8		50.7		<table style="width:100%; border-collapse: collapse;"> <tr><td style="width:50%;">Series</td><td style="width:50%; text-align:right;">10.0</td></tr> <tr><td></td><td style="text-align:right;">60.7</td></tr> </table>	Series	10.0		60.7
Series	9.8										
	50.7										
Series	10.0										
	60.7										

<p>7. Series 1 Shots</p>	<table style="width:100%; border-collapse: collapse;"> <tr><td>1:</td><td>9.4</td><td>←</td></tr> </table>	1:	9.4	←	<p>8. Series 1 Shots</p>	<table style="width:100%; border-collapse: collapse;"> <tr><td>1:</td><td>10.0</td><td>↘</td></tr> </table>	1:	10.0	↘		
1:	9.4	←									
1:	10.0	↘									
	<table style="width:100%; border-collapse: collapse;"> <tr><td style="width:50%;">Series</td><td style="width:50%; text-align:right;">9.4</td></tr> <tr><td></td><td style="text-align:right;">70.1</td></tr> </table>	Series	9.4		70.1		<table style="width:100%; border-collapse: collapse;"> <tr><td style="width:50%;">Series</td><td style="width:50%; text-align:right;">10.0</td></tr> <tr><td></td><td style="text-align:right;">80.1</td></tr> </table>	Series	10.0		80.1
Series	9.4										
	70.1										
Series	10.0										
	80.1										

<p>9. Series 1 Shots</p>	<table style="width:100%; border-collapse: collapse;"> <tr><td>1:</td><td>9.8</td><td>↙</td></tr> </table>	1:	9.8	↙	<p>10. Series 1 Shots</p>	<table style="width:100%; border-collapse: collapse;"> <tr><td>1:</td><td>9.8</td><td>↓</td></tr> </table>	1:	9.8	↓		
1:	9.8	↙									
1:	9.8	↓									
	<table style="width:100%; border-collapse: collapse;"> <tr><td style="width:50%;">Series</td><td style="width:50%; text-align:right;">9.8</td></tr> <tr><td></td><td style="text-align:right;">89.9</td></tr> </table>	Series	9.8		89.9		<table style="width:100%; border-collapse: collapse;"> <tr><td style="width:50%;">Series</td><td style="width:50%; text-align:right;">9.8</td></tr> <tr><td></td><td style="text-align:right;">99.7</td></tr> </table>	Series	9.8		99.7
Series	9.8										
	89.9										
Series	9.8										
	99.7										

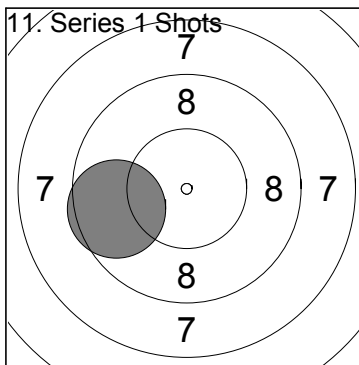

1: 9.6 ←

Series	9.6
	109.3

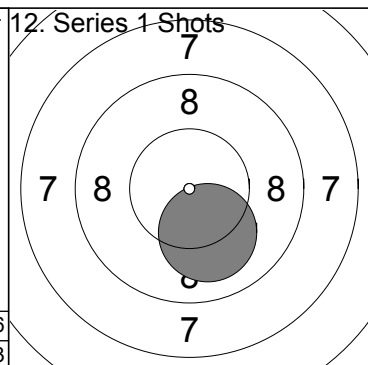

1: 10.1 ↓

Series	10.1
	119.4

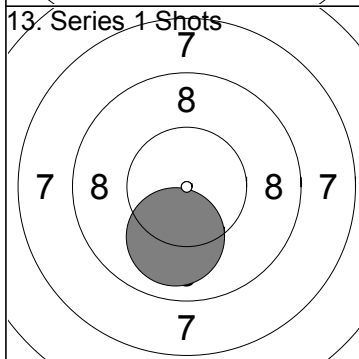

1: 10.0 ↓

Series	10.0
	129.4

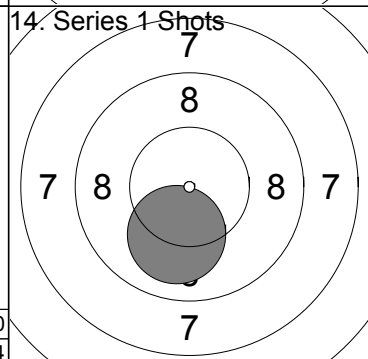

1: 10.0 ↓

Series	10.0
	139.4

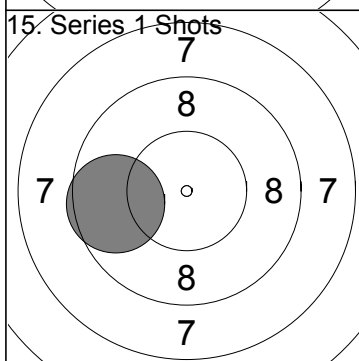

1: 9.6 ←

Series	9.6
	149.0

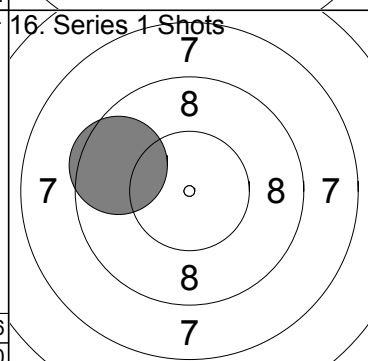

1: 9.6 ←

Series	9.6
	158.6

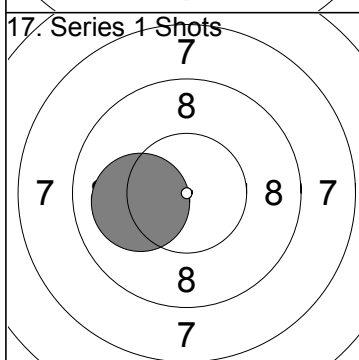

1: 10.1 ←

Series	10.1
	168.7

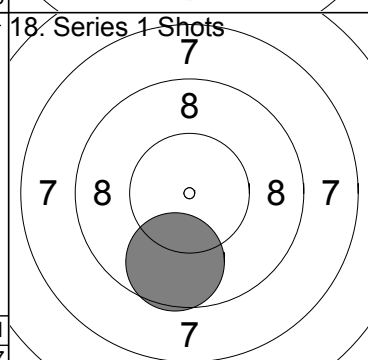

1: 9.7 ↓

Series	9.7
	178.4

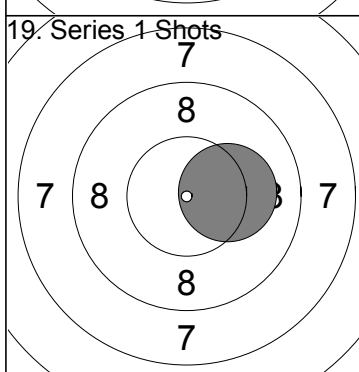

1: 10.2x →

Series	10.2
	188.6

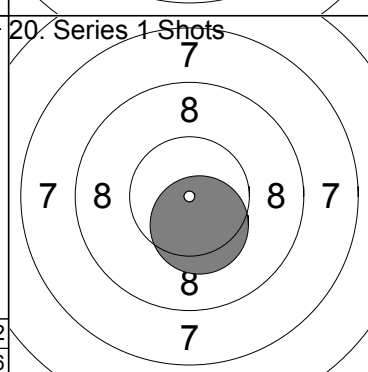

1: 10.4x ↓

Series	10.4
	199.0

--	--